

TRESTON

DEDICATED TO HUMAN WORKSPACE



Ergonomic WORKSPACES

PRODUCT CATALOGUE 2019

3D ONLINE CONFIGURATOR

CLICK • DESIGN • QUOTE

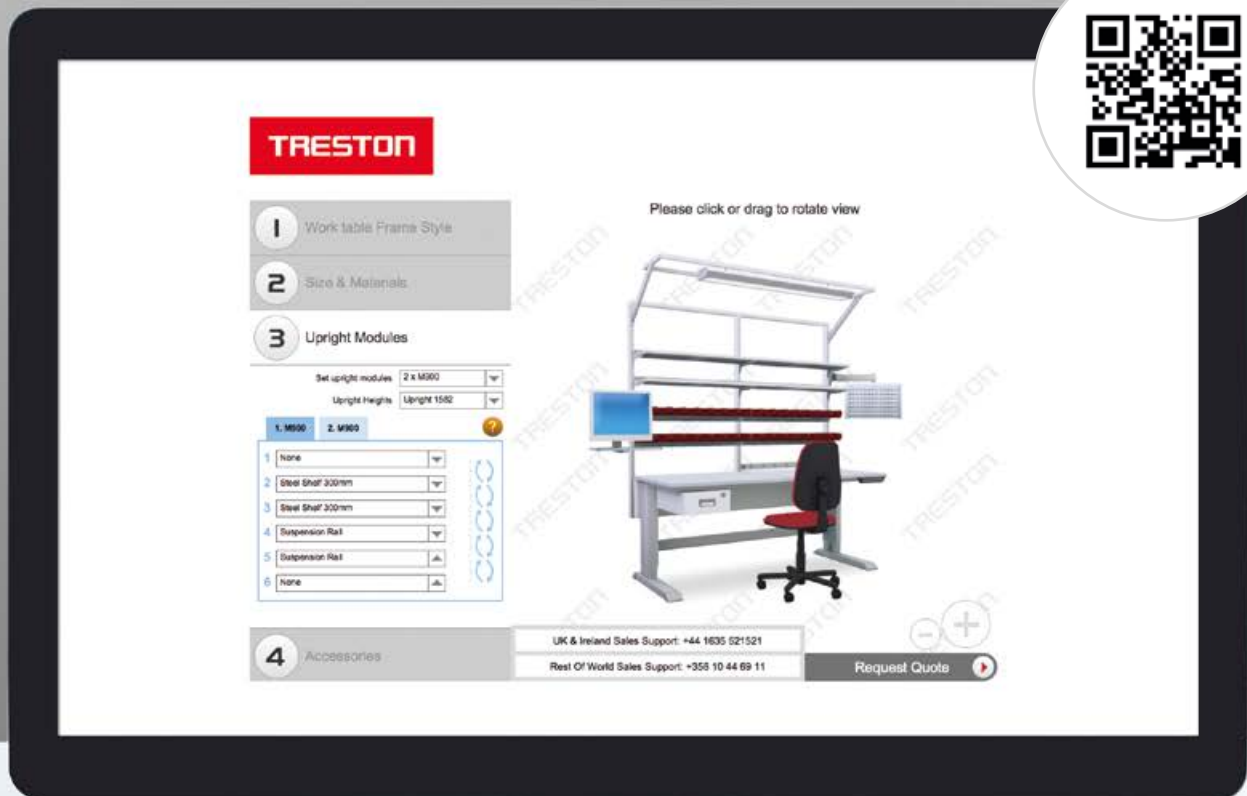

<http://3d.treston.com>



About us			4
Workstation ergonomics			8
Decorating with colour			10
ESD protection			12
Workbenches			14
WB	18	TowerLine	30
Concept	22	TP	34
LMT	28	TPH	40
Workbench accessories			42
WB			44
Concept, LMT, TowerLine, TP			48
TPH			58
Accessories that suit all benches			62
Lighting			64
Chairs			70
Trolleys			78
Universal trolley WTR	82	Reel holder trolley RRT	87
Multi trolley	83	Mobile workstation MLC	88
Basic trolley	85	Trolleys for additional workspace	89
Adjustable trolley TRTA	86		
Drawer units			90
Light steel cabinets LMC	94	Drawer unit 45	96
Drawer units 30 and 35	95		
Shelves and cabinets			100
Shelving system and cabinets	104	Industrial cabinets	106
Storage and charging cabinet	109		
Perforated panels and panel hooks			110
Perforated panels			113
Perforated industrial screens			114
Tool storage system			115
Panel hooks			116
Material flow and packing solutions			120
MultiLine			122
FlexFlow			123
Packing benches			124
Roll stands and cutters			130
Carton trolleys			132

For a Better Work Environment

DEDICATED TO

HUMAN WORKSPACE

Treston is among the world's leading suppliers of industrial furniture and workstations.

Our workstation design and implementation process always begins with the person performing the work. In this way, we pay close attention to ergonomics, functionality and efficiency.

The four cornerstones of our operations are customer-focus, reliability, high quality and continuity. We listen to your needs and reliably deliver high-quality and durable solutions, which last from one generation to the next, thanks to our optimal design.

Our own sales network and distributors dedicated to our products provide worldwide assistance and service in support of Treston products.





Industrial furniture and workstations for different working environments

Treston's product range is divided into three categories, a separate catalogue is available for each category. Please contact our agents or email us at: sales@treston.com to get your own copy.

Distinctive workshops

Our workshop drawer cabinets, tool panels and workbenches are designed to withstand heavy loads and strenuous use in workshops, repair shops and industrial environments.

The long lifetime of our furniture guarantees productivity and a satisfied user. Our workshop furniture is also well known in teaching environments.

Ergonomic workstations

The seamless efficiency of material flow is emphasised in assembly workstations.

Process changes in production or operations require reconfigurable workstations that take account of individual ergonomic requirements. Our modular product solutions allow you to react to new situations and the resulting needs in an agile manner, enabling smooth, continuous operations. Thanks to our extensive selection of accessories, we are able to satisfy even the most challenging requirements.

Treston design and years of experience enable us to customise each solution to best suit its purpose. For the needs of the electronics industry, we make ESD-protected workstations, suitable for furnishing EPAs. These workstations are also highly suitable for precision mechanics and mechanical engineering.

Swift in-house logistics

Treston storage furniture encompasses both ease of use and design. Our selection provides solutions to a surprisingly broad range of storage challenges, regardless of the users and sector.

Our plastic storage drawers are durable and easy to clean, and can be customised into a complete storage system if necessary. Our product range also includes various stand and trolley solutions, for the more efficient use of storage space and easier movement of stored goods.

We also have storage furniture for environments that require ESD protection. In addition, some of our storage solutions are moulded from recycled plastic.

Packaging and shipping departments are often found at the end of production processes. Their logistic efficiency can be easily improved through sensible workstation design.

A great deal of manual labour and quality assurance are typical of the packaging stage, in both individual stations and line solutions. Our solution for the needs of these segments often builds on the idea of "more for less".

When accessories are located and positioned according to LEAN principles, you can significantly speed up throughput and reduce work strain. Cutters, pens, knives, rubbish bins and displays can be positioned in a way that provides the user with the best possible ergonomics, while also ensuring a free and uncluttered workspace.

Workstations for every need

Optimising workstation functionality may prove difficult without well chosen accessories that increase usability. When a workstation is well planned and well equipped, workflow becomes easier and more efficient, improving ergonomics and making it easier to keep tools in place.

Modular means adaptable

Our world keeps changing at an ever-increasing pace. Until recently, products could be manufactured the same way for decades, but now we must be prepared to make changes to our work practices at a much faster rate. In order to revise the production process to meet new requirements, an extremely flexible and adaptable workstation system is essential. Our system is designed particularly with this in mind. The same basic units, equipped with accessories that meet your needs, offer a wide range of applications.

Customised for your application and your operator

The purpose of a workstation determines its basic requirements and accessories. The needs and requirements may change considerably from one employee to another, but we understand that no two people are alike. When a workstation is equipped for and adjusted to an individual's needs, each phase of the production process can be completed without delay, with accuracy and with maximum comfort.

Treston offers a wide range of ergonomic workstations to choose from, from those that can be delivered quickly to those that provide versatile options to meet any need.

STRESSTECH: CUSTOMER TESTIMONIAL

Stresstech and Treston have collaborated successfully for over 20 years. Stresstech emphasise good quality, long life-time and open communication as key drivers of success.

Stresstech uses a wide range of Treston products both in EPA areas and workshop environments, and also in their quality inspection solutions.



Check this video to get more details: <https://vimeo.com/164403605>



Ergonomics in our workstations

Costs associated with health and safety problems are an ever increasing concern to all industries. This concern drives industries to seek solutions to provide a healthy, safe and productive working environment. **Designing a workplace with ergonomics in mind improves the employees' wellbeing which in turn improves productivity.**

The modular design of Treston workstations enables proper ergonomics. With a wide range of accessories and adjustments we can provide customers with a customized solution using standard components. **Modularity and accessories are individually adjustable according to the task and operator requirements.** The aim is to

create an uncluttered workstation and utilise the available workspace as efficiently as possible.

Treston's workstations and accessories can be adjusted for operators of different heights working with left or right hand. Correctly adjusted workstations decrease stress in the muscles and enable productive work throughout the shift.

Please do remember that ergonomics is not only adjusting your chair. Comprehensive workstation ergonomics consist of proper lighting, noise absorption, body movements and air quality. More information about lighting ergonomics on page 66.

Location of the correct view angle

Focus point should follow these guidelines:

- Continual movement of view should be in 30 degree sector
- Continuous view angle should keep the head in a comfortable position (line of view should be 10 to 40 degrees below the horizontal line)
- Displays should be positioned 20 degrees below the horizontal line

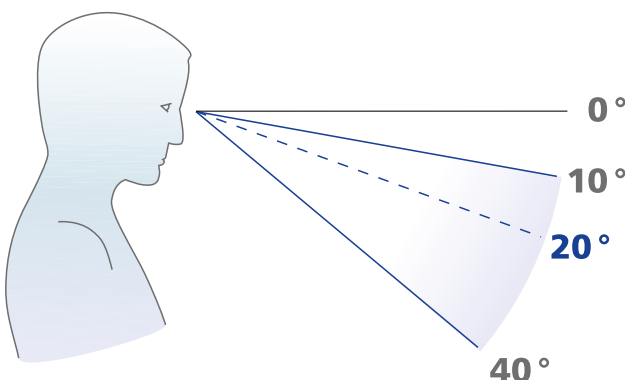

Seated or standup work?

The choice of a seated or standing working position is dependent upon the task to be executed. The height of the work surface is determined by such factors as size and weight of the part, precision requirement, assembly process, repetitiveness etc.

Height adjustability is especially useful when the size of the products being handled varies or when several people use the same workstation.

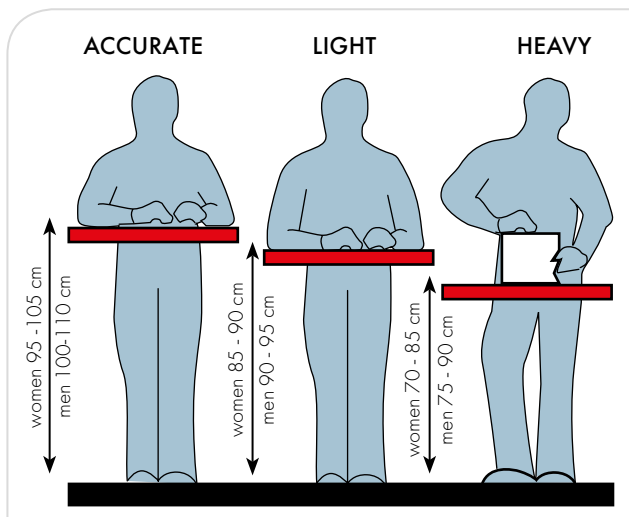

Standing work

When designing the work space for a seated operation leg space requirements must be considered. The recommended space should be at least 80 cm wide and 90 cm deep at floor level. For standing work, the required space is much smaller.

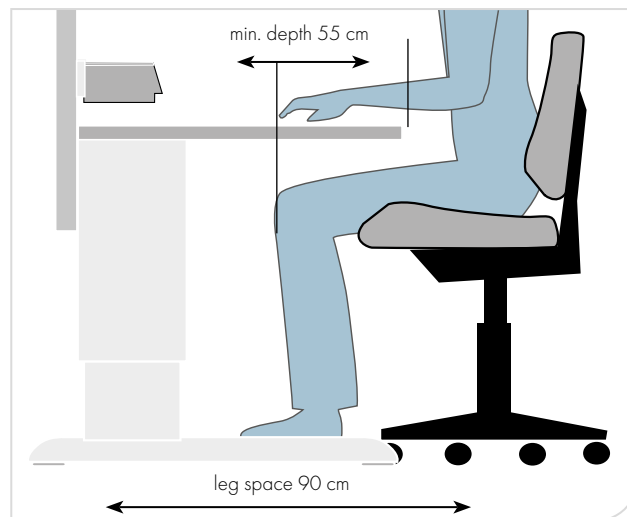

Seated work

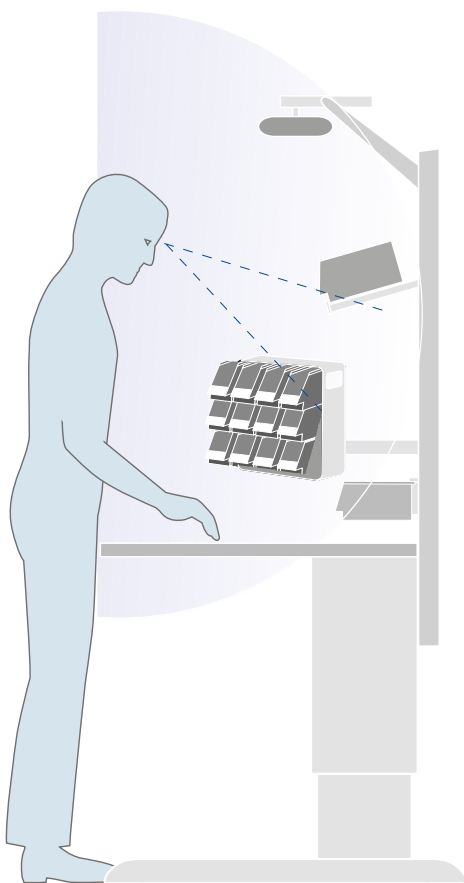

Lighting ergonomics, see page 66.

Reaching distances and heights

To improve working postures in assembly work, the most-often used parts should be placed into the optimal horizontal working area within the operator's sight. Avoid overly large or deep workbenches, which can cause improper reach and reduced productivity. Assembly work is most ergonomic when parts are within easy view and reach.

The vertical work area and reach zone can be fine-tuned with accessories. Our height adjustable arms optimize work movements and keep parts or tools within easy access. Operators can work with wrists and arms in optimal posture with shoulders relaxed. Tilted bin rails and shelves keep the wrist in a neutral position when picking parts. The tilt angle also provides easy identification of the parts with the proper viewing angle.

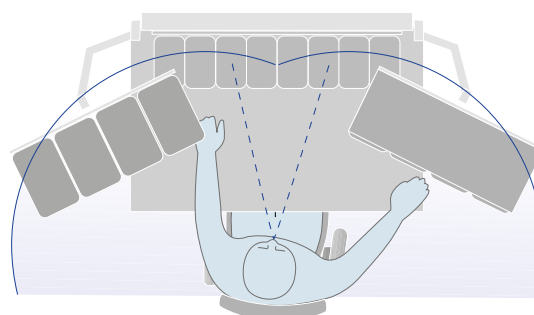



Decorating with colour

The working environment can be both attractive and inspirational. By choosing the colours of your equipment to match your corporate colours, you can reinforce your corporate image whilst creating a pleasant working environment.

Doors, drawers and perforated panels all come in various colours. The combination of different colours creates an interesting effect. Colours can also act as codes or identifiers.



Colour codes

Workbench, cabinet, shelving, drawer units and trolley frames are all light grey RAL 7035. Outside of the standard colour range, additional colours are available on request. Please contact our agents or email us at: sales@treston.com.

	Colour code	RAL code	Doors	Drawers	Perforated panels and back panels
Light grey	49* & 41**	RAL 7035 (ESD)	STD	A/STD	A/STD
Blue	07	RAL 5007	STD	A/STD	STD
Light grey	35*	RAL 7038 (ESD)	A	A	A
Dark grey	45	RAL 7045	A	A	A
Red	25	RAL 3002	A	A	A

STD = Standard factory colour, normal warehouse delivery, listed price.

A = Factory colour, delivery 15 days from the factory, listed price.

* The products ordered with the colour codes 49 (RAL 7035) and 35 (RAL 7038) are entirely ESD protected. Please note the ESD protection feature of these colours will result in a slightly darker shade of colour than the given RAL code.

**The frames of the products ordered with the colour code 41 (RAL 7035) are powder coated with a light grey ESD colour, but there are non-ESD parts in these products, such as shelves, rubber mats or castors.

STANDARD COLOURS

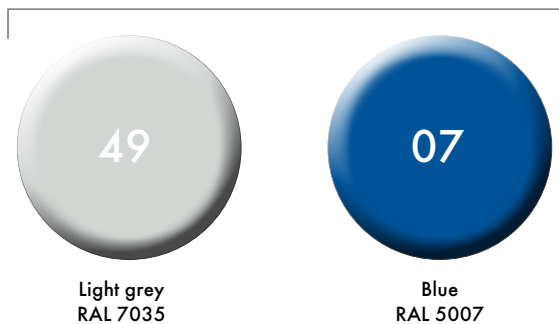

The colour code is included in those product codes that are formed with numbers.

It is either at the end, following the hyphen (e.g. 860 804-49), or in the middle (e.g. C 33407000).

FACTORY COLOURS

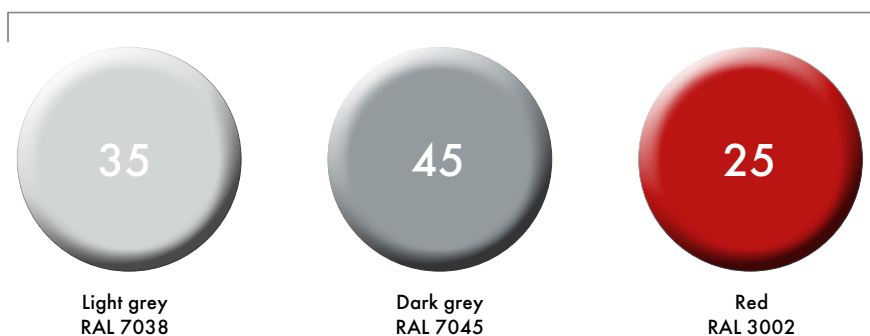

Printed colours do not give a fully accurate representation of painted colours. Please ask our agent about various samples.



ESD protection guarantees a safe working environment

Particularly in the electronics industry, work is often carried out in an EPA that is protected from static discharge. Protection in this case means effective earthing, which involves both earthing equipment and painting the frame of the ESD workstation with semi-conductive paint.

We have extensive experience in developing, manufacturing and supplying ESD furnishings. All our workstations and related products are supplied with an electrically semi-conductive coat of paint and we supply furnishings, seats and earthing components for ESD-protected workstations. We also build complete production systems equipped with ESD-protection. Our products meet the requirements specified in the IEC 61340-5-1 standard.

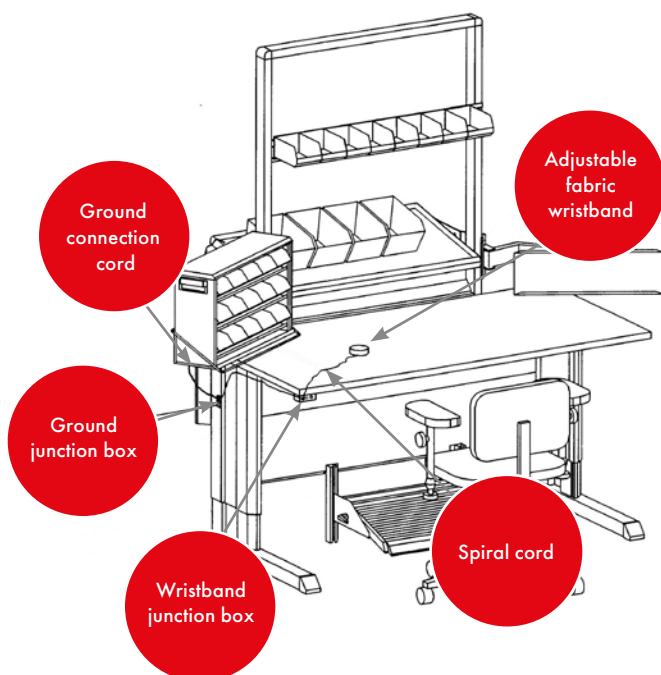

Static electricity

The abbreviation ESD stands for Electrostatic Discharge, a process that occurs between two objects of differing electric potential. Normally, electric charges are discharged slowly from objects' surfaces. If the difference in electric potential becomes too great, the electrical current accelerates resulting in a sudden current surge.

An ESD protected area is called an EPA. In an EPA, ESD protection must be observed in all materials, employees' clothing and air humidity. Workstations and employees in an EPA must also be earthed with protective resistance (1 Mohm) to an ESD earth.

Our standards comply with the highest certification requirements



<p>Quality certification</p> <p>ISO 9001 : 2015</p>	<p>Environmental Management System certification</p> <p>ISO 14001 : 2015</p>	<p>Packaging treatment following to EU directives.</p>	<p>ESD-approval certification</p> <p>Our ESD products fulfill the basic requirements of IEC 61340-5-1.</p>	<p>GS certification for lighting and TP workbench</p>
------------------------------------------------------------	-------------------------------------------------------------------------------------	---------------------------------------------------------------	-------------------------------------------------------------------------------------------------------------------	--------------------------------------------------------------

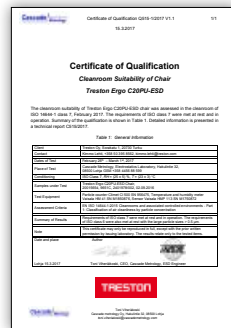

<p>Russian certificate of conformity</p>	<p>Russian certificate of conformity</p>	<p>Cleanroom Suitability of Treston Concept and WB Motorized Workstations</p> <p>ISO 14644-1, class 7</p>	<p>Cleanroom Suitability of Chair Treston Ergo C20PU-ESD</p> <p>ISO 14644-1, class 7</p>	<p>ESD certification</p> <p>Treston WB and Concept workstations fulfill the basic requirements of IEC 61340-5-1</p>
-------------------------------------------------	-------------------------------------------------	------------------------------------------------------------------------------------------------------------------	-------------------------------------------------------------------------------------------------	----------------------------------------------------------------------------------------------------------------------------

To obtain a copy of our certificates, please contact info@treston.com.

! The guarantee period for products manufactured by Treston is 5 years from the date of delivery; this excludes workbench tops, trade parts, electronic components, custom made articles and moving parts, for which there is a guarantee period of 2 years.





Workbenches



- Designed for the needs of R&D, electronics assembly and testing
- Ergonomic and easily adaptable to a large variety of tasks and environments
- Extensive range of accessories to meet any need
- Various layout possibilities from back-to-back to corner solutions



Concept workbench

- Multiple bench variations with advanced ergonomic features for quality control, packing and assembly environments
- Highly adaptable to various applications and to the needs of the user
- Superior range of accessories easily reconfigured
- Excellent stability, suitable for heavy loads up to 500 kg



LMT workbench

- Multipurpose motorised workbench for any light industrial and technical office work
- Widest height adjustment range, especially well-suited for standing work
- Comprehensive range of accessories to meet any need
- Easy and quick to adjust



TowerLine workbench

Page
30

- Ideal combination of robustness and flexibility for high tech environments
- Easy to reconfigure, serving customers' changing needs
- Wide variety of layout options from two-sided to corner solution and line extension
- Sturdy steel frame with total loading capacity of 750 kg



TP workbench

Page
34

- Standard and cost-effective workbench
- Suitable for a wide range of tasks and environments
- Superior range of accessories, easily reconfigured
- Steel frame with loading capacity up to 300 kg



TPH workbench

Page
40

- Standard and cost-effective workbench with one shelf
- Suitable for a wide range of tasks and environments
- Essential range of accessories for basic needs
- Steel frame with loading capacity up to 300 kg





WB workbenches

The WB workbench has been designed for use in demanding assembly environments. The concept is one of simplicity and good ergonomics, allowing each bench to be adapted to a variety of tasks.

Electric motor, manual hand crank or allen key height adjustment cater for standing or seated users, while the generous worktop depth and broad accessory range ensure that everything is within easy reach. Another feature of this new design is the flush bench footprint; benches can be placed side-by-side, back-to-back, or right up against walls with no unnecessary gaps. You can design your workstation to fit your needs perfectly.

Worktop height can be adjusted between 700-1100 mm. The adjustment system in both cases utilises interlocking aluminium profiles, providing a strong, rigid frame. Steel frame parts are epoxy powder coated light grey paint, RAL 7035. Worktops are of 25 mm laminated particle board, adjustable feet are provided for fine levelling.



- Designed for the needs of R&D, electronics assembly and testing
- Ergonomic and easily adaptable to a large variety of tasks and environments
- Extensive range of accessories to meet any need
- Various layout possibilities from back-to-back to corner solutions



ACCESSORIES ON PAGE 44

Extensive range of accessories available for ergonomic WB workstation.



WB workbench examples



WB electric adjustable workbench

Qty	Name	Code
1	Electric adjustable bench	WB815 EL
1	Upright profiles	AL2X150 W
1	Accessory frame	AKK150
1	Shelf	ALH150
1	Support bracket	HSB150
1	Adjustable shelf	ASH70
1	Keyboard shelf	WKA
1	Treston NaturLite LED 1200	TNL1200
1	Power channels	CJK70 SET
2	Bin profile	BP70
1	LCD bracket	MA
1	Light steel cabinet	LMC02
1	Cover	LMCK2



WB allen key adjustable workbench

Qty	Name	Code
1	Allen key adjustable bench	WB811
1	Upright profiles	AL2X110 W
1	Shelf	ALH110
1	Support bracket	HSB110
1	Treston NaturLite LED 900	TNL900
1	Adjustable shelf	ASH100
1	Power channels	CJK100



WB electric adjustable workbench ESD

Qty	Name	Code
1	Electric adjustable bench	WB815 EL ESD
1	Upright profiles	AL2X150 W
1	Accessory frame	AKK150
1	Shelf	ALH150 ESD
2	Adjustable shelf	ASH70 ESD



WB allen key adjustable workbench ESD

Qty	Name	Code
1	Allen key adjustable bench	WB815 ESD
1	Upright profiles	AL2X150 W
1	Accessory frame	AKK150
1	Shelf	ALH150 ESD
1	Support bracket	HSB150
1	Treston NaturLite LED 1200	TNL1200
1	Adjustable shelf	ASH70 ESD
1	Perforated panel	ARL70
1	Power channels	CJK70 SET
2	Treston NaturLite LED Wing 500	TNL500W

Designing WB workbench



- Select the height adjustment method: allen key, electric or crank.
- Stepless height adjustment between 700-1100 mm.
- Select a bench top to suit the frame: laminate or ESD bench top.

WB allen key adjustable bench

Bench size W x D mm	Max load kg	Code	Code ESD
1073 x 800	250	WB811	WB811 ESD
1500 x 800	250	WB815	WB815 ESD
1800 x 800	250	WB818	WB818 ESD

WB electric adjustable bench

Bench size W x D mm	Max load kg	Code	Code ESD
1073 x 800	200	WB811 EL	WB811 EL ESD
1500 x 800	200	WB815 EL	WB 815 EL ESD
1800 x 800	200	WB818 EL	WB818 EL ESD

Adjustment speed using the motor is 19 seconds min. to max.

Cable tidy as standard.

WB crank adjustable bench

Bench size W x D mm	Max load kg	Code	Code ESD
1073 x 800	200	WB811 C	WB811 C ESD
1500 x 800	200	WB815 C	WB815 C ESD
1800 x 800	200	WB818 C	WB818 C ESD

Cable tidy as standard.



Laminate bench top

- 25 mm low pressure laminate
- Light grey surface
- Plastic edging

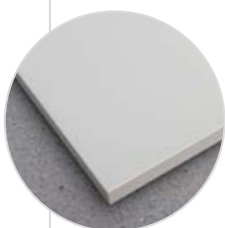

ESD bench top

- Light grey laminate surface
- Grey edging
- Thickness 25 mm
- Semi-conductive (ESD)

The WB bench can be equipped with castors!



Castor set Ø100 ESD Code LCS100 ESD

Castor set Ø100 Code LCS100

Load capacity with castors is the same as the bench loading capacity with adjustable screws. We recommend using the cable tidy WBCT with WB Allen-key adjustable benches.

WB extension benches



1. WB side worktop

This side worktop can be installed on either the right or left hand side of a WB bench to increase the surface area. Installation can be either at the same height, or lower than the main worktop with the brackets provided. Load capacity is 40 kg, and it is suitable for all WB models in the range.

Size W x D mm	Max load kg	Code	Code ESD
400 x 800	40	WB804 ST	WB804 ST ESD

2. WB corner worktop

A corner worktop can be used with two WB benches to create a 90° angle setup. This unit consists of a worktop and all necessary components. It requires no additional leg frames, simply mounting to the standard benches with the brackets provided. Load capacity for this worktop is 80 kg. Doesn't suit handle adjustable bench. Suitable for WB EL to order.

Size W x D mm	Max load kg	Code	Code ESD
1154 x 1154	80	WB1212 CT	WB1212 CT ESD

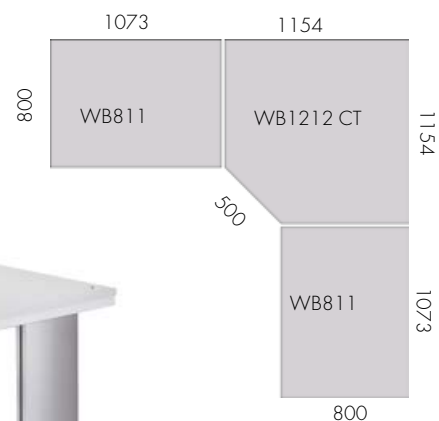



Concept workbenches

Concept workbenches are designed for the needs of the electronics industry, where ergonomic qualities are the most important requirement. There are many possible adjustments, all components fit together seamlessly, and each detail is practical in use.

The workstation adapts to the work process and the needs of the operator. As a result all movements of the operator can be optimised, which in turn increases performance and productivity and decreases work-related stress.

Modular design provides total integration with the existing system and the potential to flexibly adapt to changes in the environment. Concept workbenches are typically used in assembly, quality control and repair work.

Concept workbenches are also available in allen key, hand crank and motor adjustable versions.



- Multiple bench variations with advanced ergonomic features for quality control, packing and assembly environments
- Highly adaptable to various applications and the needs of the user
- Superior range of accessories easily reconfigured
- Excellent stability, suitable for heavy loads up to 500 kg



ACCESSORIES ON PAGE 48

Superior range of accessories available for ergonomic Concept workstation.



Concept workbench examples



Concept allen key adjustable workbench

Qty	Name	Size mm	Code
1	Frame	1500 x 750	100 49 032P
1	Laminate bench top	1500 x 750	TT15075-HPL



Concept motor adjustable bench

Qty	Name	Size mm	Code
1	Frame	1500 x 750	103 49 032P
1	Laminate bench top	1500 x 750	TT15075-HPL



Concept hand crank adjustable bench

Qty	Name	Size mm	Code
1	Frame	1500 x 750	101 49 032
1	Laminate bench top	1500 x 750	TT15075-HPL



Concept ESD workstation

Qty	Name	Size mm	Code
1	Allen key adjustable frame	1500 x 750	100 49 032P
1	ESD bench top	1500 x 750	TT15075-ESD
1	Upright tube module	2 x M750	903 49 001P
1	Light and balancer rail	2 x M750	918 49 006P
1	Steel shelf	M750 x 300	836 028-49
1	Steel shelf	M750 x 400	852 770-49
1	Divider pair	385 x 190	010 005-49
1	Bin rail	M750	859 151-49
1	LCD screen holder with a double arm		930 49 002P
1	Keyboard tray for LCD holder		860 941-49
1	Fixing set for drawer unit		860 930-49
1	Drawer unit 30/22 with an electronic code lock		720 010-49
1	Accessory bar		860 088-49
1	CPU holder for accessory bar		860 551-49
1	Treston NaturLite LED 1200		TNL1200
2	Perforated panel	M750 x 1003	861 514-49

The Concept bench can be equipped with castors!



Castor set Ø100 ESD Code 860 429 -00

Castor set Ø100 Code 834 734 -00

Load capacity with castors 300 kg.

Designing Concept workstation

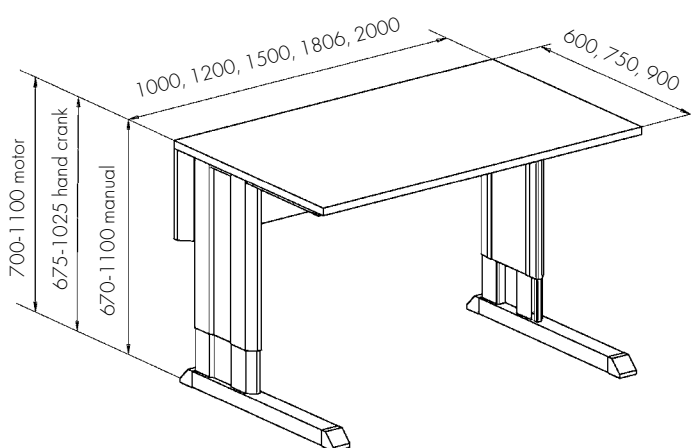

- Select the bench frame and the height adjustment method: allen key, hand crank or motor.
- Select a bench top to suit the frame: HPL laminate, LPL laminate or ESD bench top.



Concept workbench frame

Workbench frame size W x D mm	Bench frame, allen key adjustable Code	Bench frame max load kg	Bench frame, hand crank adjustable Code	Bench frame max load kg	Bench frame, motor adjustable Code	Bench frame max load kg
1000 x 600	100 49 015P	500	101 49 015	200	103 49 015P	400
1000 x 750	100 49 030P	500	101 49 030	200	103 49 030P	400
1000 x 900	100 49 062P	500	101 49 062	200	103 49 062P	400
1200 x 600	100 49 016P	500	101 49 016	200	103 49 016P	400
1200 x 750	100 49 031P	500	101 49 031	200	103 49 031P	400
1200 x 900	100 49 063P	500	101 49 063	200	103 49 063P	400
1500 x 600	100 49 017P	500	101 49 017	200	103 49 017P	400
1500 x 750	100 49 032P	500	101 49 032	200	103 49 032P	400
1500 x 900	100 49 064P	500	101 49 064	200	103 49 064P	400
1800 x 600	100 49 018P	500	101 49 018	200	103 49 018P	400
1800 x 750	100 49 033P	500	101 49 033	200	103 49 033P	400
1800 x 900	100 49 065P	500	101 49 065	200	103 49 065P	400
2000 x 600	100 49 019P	500			103 49 019P	400
2000 x 750	100 49 034P	500			103 49 034P	400
2000 x 900	100 49 066P	500			103 49 066P	400
Bench height steplessly adjustable	670 - 1100 mm		675 - 1025 mm		700 - 1100 mm	

Concept hand crank adjustable frames with extended crank set for 900 mm deep bench top

Workbench frame size W x D mm	Bench frame max load kg	Code
1500 x 750	200	101 49 042
1800 x 750	200	101 49 043

Laminate bench top -HPL

- Light grey high pressure laminate
- Plastic edging
- Thickness 25 mm

Laminate bench top -LPL

- Light grey low pressure laminate
- Plastic edging
- Thickness 25 mm

ESD bench top

- Light grey laminate surface
- Grey edging
- Thickness 25 mm
- Semi-conductive (ESD)

Concept bench tops

Size W x D mm	Code HPL	Code LPL	Code ESD
1000 x 600	TT10060-HPL	TT10060-LPL	TT10060-ESD
1000 x 750	TT10075-HPL	TT10075-LPL	TT10075-ESD
1000 x 900	TT10090-HPL	TT10090-LPL	TT10090-ESD
1200 x 600	TT12060-HPL	TT12060-LPL	TT12060-ESD
1200 x 750	TT12075-HPL	TT12075-LPL	TT12075-ESD
1200 x 900	TT12090-HPL	TT12090-LPL	TT12090-ESD
1500 x 600	TT15060-HPL	TT15060-LPL	TT15060-ESD
1500 x 750	TT15075-HPL	TT15075-LPL	TT15075-ESD
1500 x 900	TT15090-HPL	TT15090-LPL	TT15090-ESD
1806 x 600	TT18060-HPL	TT18060-LPL	TT18060-ESD
1806 x 750	TT18075-HPL	TT18075-LPL	TT18075-ESD
1806 x 900	TT18090-HPL	TT18090-LPL	TT18090-ESD
2000 x 600	TT20060-HPL	TT20060-LPL	TT20060-ESD
2000 x 750	TT20075-HPL	TT20075-LPL	TT20075-ESD
2000 x 900	TT20090-HPL	TT20090-LPL	TT20090-ESD

Concept extension benches

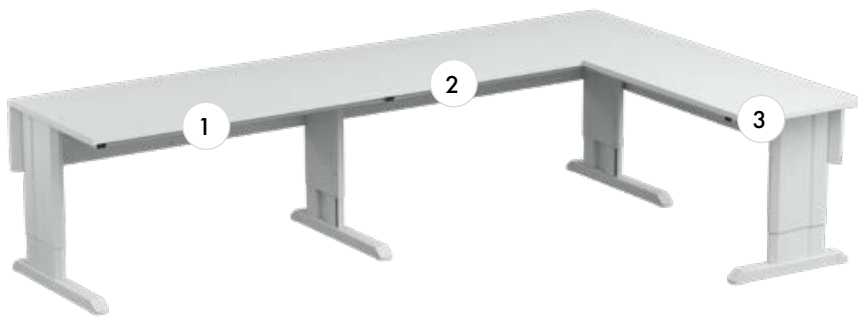

- 1. Workbench frame,
- 2. Extension bench frame
- 3. Corner bench frame

Concept extension bench frame (right)

Name	Size W x D mm	Max load kg	Code
Extension bench frame	1500 x 600	250	112 49 001P
Extension bench frame	1500 x 750	250	112 49 002P
Extension bench frame	1806 x 750	250	112 49 003P

Concept corner bench frame (right)

Name	Size W x D mm	Max load kg	Code
Corner bench frame for allen key adjustable bench 600 mm deep	1000 x 600	250	111 49 001P
Corner bench frame for allen key adjustable bench 750 mm deep	1200 x 600	250	111 49 002P

Concept extension bench frame (left)

Name	Size W x D mm	Max load kg	Code
Extension bench frame	1500 x 600	250	112 49 004P
Extension bench frame	1500 x 750	250	112 49 005P
Extension bench frame	1806 x 750	250	112 49 006P

Concept corner bench frame (left)

Name	Size W x D mm	Max load kg	Code
Corner bench frame for allen key adjustable bench 600 mm deep	1000 x 600	250	111 49 003P
Corner bench frame for allen key adjustable bench 750 mm deep	1200 x 600	250	111 49 004P

Transport skate

With a transport skate, one person can easily move benches. For long-distance moving, you will need two transport skates.

Name	Max load kg	Code	Code ESD
Transport skate	180	854 061-41	854 061-49

Compatible with tables with a max depth of 750 mm.



Accessories from page 48 and 95

Superior range of accessories available for ergonomic Concept workstation.

Concept upright tubes



Accessories from page 48

Superior range of accessories available for ergonomic Concept workstation.

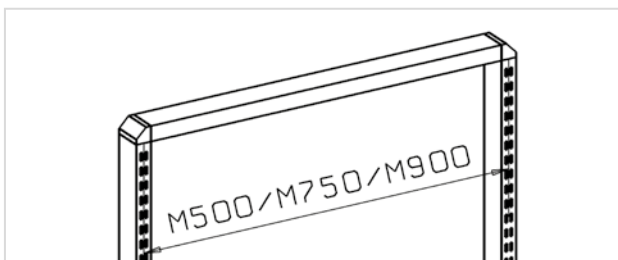

The modular (M) size refers to the distance between two upright tubes from the middle of the tube. The modular size is used to find the appropriate accessories.

The upright tubes can also be used separately without the horizontal tubes. In this case, please order the end cap 900370-00 for the upright tubes (1 pcs per upright tube).

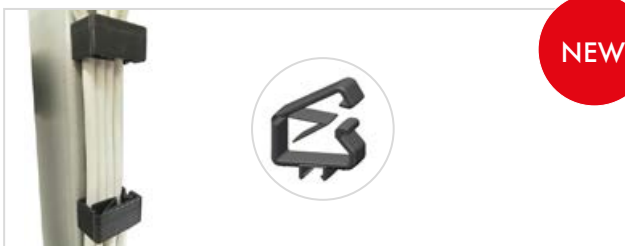

CC cable clip set CC5

Name	Suitable for	Code
Cable clip set (5 pcs)	Upright tubes	CC5

For easy cable management, suitable for up to five cables.

Accessories are attached to the Concept bench with the aid of upright tubes or a complete, upright tube module.

The module includes upright tubes, horizontal tube/tubes, corner bracket pair and straight bracket (if module has more than one horizontal tube). The tubes or the module are attached to the back of the bench.

Upright tubes

Name	Size W x D mm	Length (l) mm	Code
Upright tube	30 x 60	500	860 991-49
Upright tube	30 x 60	800	860 142-49
Upright tube	30 x 60	996	860 367-49
Upright tube	30 x 60	1359	860 024-49
Upright tube	30 x 60	1582	860 025-49
Horizontal tube	M500		860 819-49
Horizontal tube	M750		847 402-49
Horizontal tube	M900		840 104-49
Horizontal tube	M1000		854 656-49
Horizontal tube	M1200		854 655-49
Horizontal tube	M1350		850 914-49
Horizontal tube	M1500		854 654-49
Horizontal tube	M1800		854 657-49
Corner bracket pair			848 336-49
Straight bracket			851 827-49

Upright tube modules and compatibility

	Suitable for bench widths C = Concept					Code	Code
	1000	1200	1500	1800	2000	l=1359 mm h=1075 mm	l=1582 mm h=1300 mm
1 x M750	C	C	C	C	C	900 49 001P	900 49 002P
1 x M900	C	C	C	C	C	901 49 001P	901 49 002P
2 x M500	C	C				902 49 001P	902 49 002P
2 x M750			C	C	C	903 49 001P	903 49 002P
2 x M900				C	C	904 49 001P	904 49 002P
3 x M500			C	C	C	905 49 001P	905 49 002P
4 x M500					C	906 49 001P	906 49 002P

h = module's height measured from Concept bench's top surface.

Load capacity 100 kg / module spacing.

Upright tube modules are available also with 996 mm uprights (h=714 mm).
Item codes: 90x49003P.

Upright tube modules include 5 pcs of cable clips for easy cable management.

Aluminium bracket

Name	Code
Aluminium bracket	846 554-00



A separate aluminium bracket (846 554-00) can be used to attach a single tube to any bench.

Concept also accommodates the most demanding packaging needs!

Whatever the packaging need, you can build it from Concept and its modular elements.

Modules fit together seamlessly, giving you an opportunity to create a complete packaging solution, perfectly matching your needs. Building packaging combinations from varying, yet standard modules makes it possible to create an ergonomically well-functioning packaging solution which is also robust and economic. No need for costly extra modifications or compromises!



Read more about Treston packing benches from our separate brochure, or check the selection on page 126.



Largest number of accessories on the market.

treston.com/company/catalogues-and-brochures





Light motorbench LMT

LMT is a light duty motorized ergonomic multi-purpose workbench that can be equipped for many environments. The LMT system is well suited for light industrial, laboratory, light assembly, quality control, packaging and technical offices.

LMT is designed to meet ergonomic standards for users in both seated and standing positions. The table frame is quickly adjusted using an integrated linear actuator system, providing height adjustment from 645 mm to 1145 mm. The workbench is available in four modular sizes - M1000, M1200, M1500 and M1800. Attaching the upright tube modules will give you the opportunity to add a wide range of accessories to the bench. The bench has a load capacity of 150 kg with the uprights supporting 80 kg, evenly loaded.



- Multipurpose motorised workbench for any light industrial and technical office work
- Widest height adjustment range, especially well-suited for standing work
- Comprehensive range of accessories to meet any need
- Easy and quick to adjust



ACCESSORIES ON PAGE 48

Comprehensive range of accessories available for ergonomic LMT workstation



WATCH THIS ANIMATION showcasing the versatile usage options of our technical furniture: LMT | <https://vimeo.com/215614711>

Designing LMT workstation



- LMT workbench consists of the bench top, frame and spacer bar.
- Upright tube module and accessories are ordered separately.
- 25 mm low pressure laminate worktop with plastic edging

LMT workbench

Size W x D mm	Max load kg	Code	Code ESD
M1000 x 750	150	854 650-41	854 650-49
M1200 x 750	150	854 651-41	854 651-49
M1500 x 750	150	854 652-41	854 652-49
M1800 x 750	150	854 660-41	854 660-49



Laminate bench top

- 25 mm low pressure laminate
- Light grey surface
- Plastic edging

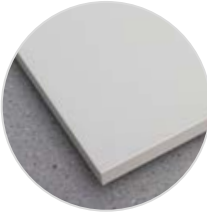

ESD bench top

- Light grey laminate surface
- Grey edging
- Thickness 25 mm
- Semi-conductive (ESD)



LMT upright tube modules

Accessories are attached to the LMT bench with the aid of a complete, upright tube module. Upright parts are attached to both sides of the LMT workbench. Upright tube module includes two upright tubes, one horizontal tube corner brackets and fixing brackets. Choose the module size as per the workbench size.

LMT upright tube modules

Module	Height, mm	Code
M1000	996	854 926-49
M1200	996	854 925-49
M1500	996	854 924-49
M1800	996	854 928-49

Upright tube modules include 5 pcs of cable clips.



TowerLine workbench

The Treston TowerLine has a sturdy steel frame and is available in a wide range of layout options. The bench can be easily reconfigured to meet new requirements. TowerLine is also ESD compatible, with a large variety of add-on accessories and easy cable management. It adapts to changing needs in a number of ways providing maximum return on investment.

The TowerLine is an ideal solution for the electronics industry, high tech labs, IT departments, technical school environments, assembly, R&D and other technical office areas.

The TowerLine offers the superb ergonomic features that come with every Treston bench. In addition, there are specific new features designed for environments containing electronics, lab equipment or cabling.



- Ideal combination of robustness and flexibility for high tech environments
- Easy to reconfigure, serving customers' changing needs
- Wide variety of layout options from two-sided to corner solution and line extension
- Sturdy steel frame with loading capacity of 750 kg



ACCESSORIES ON PAGE 48

Comprehensive range of accessories available for ergonomic TowerLine workstation.



TowerLine workbench examples



TowerLine one-sided workstation

Qty	Name	Size mm	Code
1	Standard frame	M1500	890 351-49
1	Laminate bench top	M1500 x 750	TT15775TL
2	Steel shelf	M1500 x 300	854 481-49
2	Perforated panel	M1500 x 389	861 526-49
1	Drawer unit 45/26, 100% opening	Drawers 2 x 100	604 49 001
1	Drawer unit fixing set	M1500	854 463-49
1	Light and balancer rail	M1500	918 49 006P
1	Treston NaturLite LED 1200	1180	TNL1200



TowerLine extension workstation

Qty	Name	Size mm	Code
1	Standard frame	M1500	890 351-49
2	Laminate bench top	M1500 x 750	TT15775TL
1	Extension frame	M1500	890 358-49
4	Steel shelf	M1500 x 300	854 481-49
2	Perforated panel	M1500 x 389	861 526-49



TowerLine two-sided workstation

Qty	Name	Size mm	Code
1	Standard frame	M1500	890 351-49
4	Laminate bench top	M1500 x 750	TT15775TL
1	Extension frame	M1500	890 358-49
1	Bracket set for standard frame	M1500	890 355-49
1	Bracket set for extension frame	M1500	890 421-49



TowerLine corner workstation

Qty	Name	Size mm	Code
1	Standard frame	M1500	890 351-49
2	Laminate bench top	M1500 x 750	TT15775TL
1	Extension frame	M1500	890 358-49
1	Corner bench frame	981 x 981	890 353-49
1	Laminate corner bench top	981 x 981	TT9898TLC
4	Steel shelf	M1500 x 300	854 481-49
1	Corner perforated panel		890 411-49

Designing TowerLine workstation

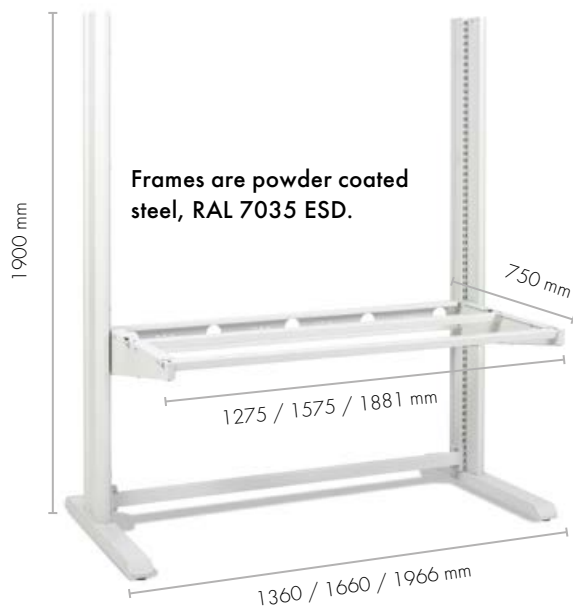

- Comes in a wide variety of layout options: the two-sided option, corner solution and line extension.
- Any TowerLine combination always starts with a standard frame. The extension and corner bench frames are always installed in conjunction with the standard frame, not as stand-alone benches.
- Bench tops are also ordered separately.

① TowerLine one-sided solutions

	Module	Code
Standard frame	M1200	890 350-49
Standard frame	M1500	890 351-49
Standard frame	M1800	890 352-49
Extension frame	M1200	890 357-49
Extension frame	M1500	890 358-49
Extension frame	M1800	890 359-49



② TowerLine two-sided solutions

	Module	Code
Bracket set for standard frame	M1200	890 354-49
Bracket set for standard frame	M1500	890 355-49
Bracket set for standard frame	M1800	890 356-49
Bracket set for extension frame	M1200	890 422-49
Bracket set for extension frame	M1500	890 421-49
Bracket set for extension frame	M1800	890 420-49



③ TowerLine corner bench frame

	Size mm	Code
Corner bench frame	981 x 981	890 353-49



TowerLine bench tops

	Size mm	Code
Laminate bench top	M1200 x 750	TT12775TL
ESD bench top	M1200 x 750	TT12775TL-ESD
Laminate bench top	M1500 x 750	TT15775TL
ESD bench top	M1500 x 750	TT15775TL-ESD
Laminate bench top	M1800 x 750	TT18875TL
ESD bench top	M1800 x 750	TT18875TL-ESD
Laminate corner bench top	981 x 981	TT9898TLC
ESD corner bench top	981 x 981	TT9898TLC-ESD

Laminate bench top: Light grey, high pressure laminated surface with grey edging, thickness 25 mm.
ESD bench top: Light grey, semi-conductive (ESD) low pressure laminated surface with grey edging, thickness 25 mm.

TowerLine can be easily extended with the addition of an extension frame. A single sided workstation can be easily converted into a double sided workstation by adding an additional bench top and bracket set.

This is TowerLine:

Ergonomic, easy to personalise

Like all Treston workbenches, the TowerLine has been designed to be ergonomically functional. The leg space, lighting, free re-positioning of accessories as well as many other aspects of ergonomic workspaces have been taken into account.

ESD compatible

The TowerLine frame is ESD compatible, enabling easy reconfiguration to an ESD setup by simply changing the bench top.

Enables precise work in challenging conditions

The stable steel frame withstands 750 kg. The maximum load per bench top is 200 kg and each shelf holds up to 80 kg. The bench height is freely adjustable with brackets, making levelling easy to accomplish.

A tidy, safe and aesthetic solution

Using TowerLine's vertical 'tower' legs and a horizontal rear case, electrical cables can be hidden, creating a clean and streamlined workplace. The cable holes are also designed for easy access.

Makes best use of floor space

The bench height is freely adjustable in an exceptionally wide range of 270 mm - 1915 mm. This enables you to make full use of the required floor space. For example, set-ups can include two full-size bench tops and space for a lot of additional equipment.





TP workbenches

The classically designed TP workbench is the ideal basic bench, the simplest and the most cost-effective option in our range of workbenches. TP workbenches are standard benches that are suitable for a broad range of tasks and environments when fitted with accessories: testing, packing, repairing, inspecting. TP bench is guaranteed for regular use with loads up to 300 kg.

Designed for use in today's production and assembly environments, this definitive modular system, developed over more than 35 years, provides a high quality working environment. Customise your workstation to your own requirements.

Stepless height adjustment

The height of workbenches in our TP range can be steplessly adjusted from 650 to 900 mm, which makes these benches suitable for work while sitting or standing. Packing is a typical example of work where the workbench height must be set correctly for the height of the user.



- Standard and cost-effective workbench
- Suitable for a wide range of tasks and environments
- Superior range of accessories, easily reconfigured
- Steel frame with loading capacity up to 300 kg



ACCESSORIES ON PAGE 48

Superior range of accessories available for ergonomic TP workstation



TP workbench examples



TP workbench

Qty	Name	Size mm	Code
1	Workbench TP	1500 x 700	TP715
1	Accessory frame	1500	TPK15-49
1	Upright tube module	2 x M750	903 49 001P



TP workbench

Qty	Name	Size mm	Code
1	Workbench TP	1500 x 700	TP715
1	Accessory frame	1500	TPK15-49
1	Upright tube module	2 x M750	903 49 002P
1	Light/balancer rail	2 x M750	918 49 006P
1	Treston Naturlite LED1200	1180	TNL1200
2	Metal shelf	M750 x 300	836 028-49
2	Bin profile	M750	859 151-49
10	Stacking bin		1525-5



TP upright frame with bench top

Qty	Name	Size mm	Code
1	TP upright frame	M900 x 1850	123 49 008
1	ESD bench top	1200 x 600	TT12060-ESD
1	Bracket pair		860 139-49

The TP bench can be equipped with castors!



Castor set Ø100, code 834 734 -00

Castor set Ø100 ESD, code 860 429 -00

Insert set (required to fit castors), code 853 289-00

Load capacity with castors 150 kg. We recommend using the fixing frame for the castors.

Designing TP workstation



- Stepless height adjustment with allen key between 650-900 mm.
- Frames are of epoxy powder coated steel in light grey RAL 7035.
- Upright tubes (ordered separately) allow to attach a wide range of accessories.

Laminate bench top

- 25 mm low pressure laminate
- Light grey surface
- Plastic edging

ESD bench top

- Light grey laminate surface
- Grey edging
- Thickness 25 mm
- Semi-conductive (ESD)

TP workbench

Bench size W x D mm	Max load kg	Code	Code ESD
700 x 500	150	TP507	TP507 ESD
1000 x 500	150	TP510	TP510 ESD
1500 x 500	150	TP515	TP515 ESD
1000 x 700	300	TP710	TP710 ESD
1200 x 700	300	TP712	TP712 ESD
1500 x 700	300	TP715	TP715 ESD
1800 x 700	300	TP718	TP718 ESD
1500 x 900	300	TP915	TP915 ESD
1800 x 900	300	TP918	TP918 ESD

1. Lower shelf for TP

Name	Size W x D mm	Max load kg	Code
Lower shelf	1080 x 500	50	AT 120TPH
Lower shelf	1380 x 500	50	AT 150TPH
Lower shelf	1680 x 500	50	AT 180TPH

Not enough space above the workstation? Then utilise the space below. The lower shelf for TP bench simply hangs on the horizontal bars.

2. Lower steel shelf LSS

Name	Size W x D mm	Max load kg	Code
Lower shelf	1418 x 460	30	LSS150
Lower shelf	1718 x 460	30	LSS180
Low M-divider hoops (4 pcs/set)	460 x 315		LDH

Hangs on the horizontal bars. Can be equipped with steplessly adjustable low M-divider hoops.

3. Side worktop

Name	Size W x D mm	Max load kg	Code
Side worktop	400 x 700	35	TP704 ST
Side worktop	400 x 900	35	TP904 ST

Easy to fix to the legs of the bench. Can be fixed on the left or right side of the bench and brackets placed either above or underneath. Height adjustable 575-900 mm from the floor.



TP extension benches

Line extension TP-L

Each standard TP bench may also be supplied as a line extension. Fitted to the side of the main bench.

Bench size W x D mm	Max load kg	Code	Code ESD
1000 x 700	150	TP710 L	TP710 L ESD
1200 x 700	150	TP712 L	TP712 L ESD
1500 x 700	150	TP715 L	TP715 L ESD
1800 x 700	150	TP718 L	TP718 L ESD
1500 x 900	150	TP915 L	TP915 L ESD
1800 x 900	150	TP918 L	TP918 L ESD



Angle extension TP-K

Each standard TP bench may also be supplied as an angle extension. Fitted to front angle of main bench.

Bench size W x D mm	Max load kg	Code	Code ESD
1000 x 500	150	TP510 K	TP510 K ESD
1200 x 700	150	TP712 K	TP712 K ESD



Corner workbench TP-KK

A corner workbench can be used with two TP benches (with one H-frame pair) to create a 90 ° angle setup. TP KK unit consists of a worktop, two H-frames and a leg in the middle. Front side 565 mm.

Bench size W x D mm	Max load kg	Code	Code ESD
1100 x 1100	150	TP707 KK	TP707 KK ESD
1300 x 1300	150	TP909 KK	TP909 KK ESD



* Workbench with one H-frame pair.

SAP trolley

Construction as TP bench. Height adjustment with allen key between 650-900 mm. Swivel castors (Ø 100 mm), two of which have brakes. Load capacity 150 kg. Lower shelf and push handle available separately.

Name	Size W x D mm	Max load kg	Code	Code ESD
Trolley	700 x 500	150	SAP507	SAP507 ESD
Trolley	1000 x 700	150	SAP710	SAP710 ESD
Trolley	1500 x 700	150	SAP715	SAP715 ESD
Lower shelf	700 x 500	40	AT507	AT507 ESD
Lower shelf	1000 x 700	40	AT710	AT710 ESD
Handle	depth 500		PUSH50	PUSH50
Handle	depth 700		PUSH70	PUSH70



SAP trolley with AT lower shelf and PUSH handle.

TP upright tubes

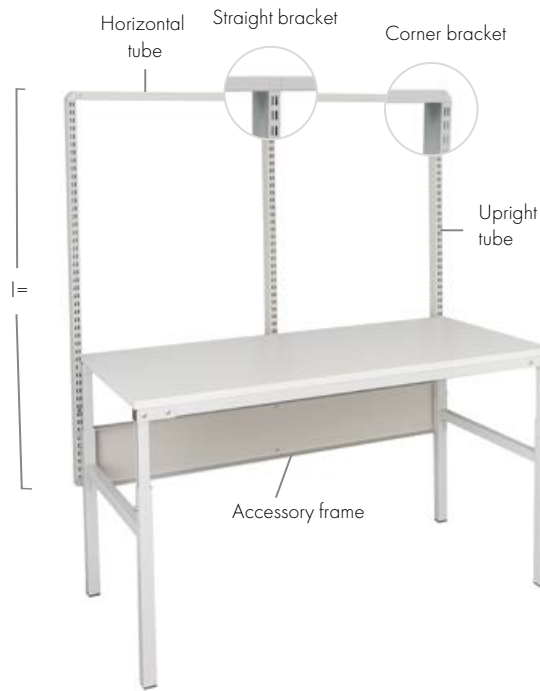

Accessory frame

Upright tubes

Name	Size W x D mm	Length (l) mm	Code
Upright tube	30 x 60	500	860 991-49
Upright tube	30 x 60	800	860 142-49
Upright tube	30 x 60	996	860 367-49
Upright tube	30 x 60	1359	860 024-49
Upright tube	30 x 60	1582	860 025-49
Horizontal tube	M500		860 819-49
Horizontal tube	M750		847 402-49
Horizontal tube	M900		840 104-49
Horizontal tube	M1000		854 656-49
Horizontal tube	M1200		854 655-49
Horizontal tube	M1350		850 914-49
Horizontal tube	M1500		854 654-49
Horizontal tube	M1800		854 657-49
Corner bracket pair			848 336-49
Straight bracket			851 827-49

Aluminium bracket

Name	Code
Aluminium bracket	846 554-00

Bracket can be used to attached a single tube to the bench.



Upright tube with aluminium bracket attached to the bench.

Accessories are attached to the TP bench with the aid of upright tubes or a complete, upright tube module.

The module includes upright tubes, horizontal tube/tubes, corner bracket pair and straight bracket (if module has more than one horizontal tube). The upright tubes or the upright tube module are attached to the back of the TP bench with accessory frame (ordered separately). When using three upright tubes with the bench, we recommend using the complete upright tube modules.



Accessories from page 48

Superior range of accessories available for ergonomic TP workstation.

Accessory frame

Bench frame width mm	Fixing points for uprights	Code
1000	1 x M900, 1 x M1000	TPK10-49
1200	1 x M750, 1 x M900, 1 x M1200	TPK12-49
1500	1 x M1500, 2 x M750	TPK15-49
1800	1 x M1800, 2 x M900	TPK18-49

Upright tubes or the upright tube module are always attached to TP bench with accessory frame. The accessory frame cannot be used on line or corner extensions.

Upright tube modules and compatibility

	Suitable for bench widths TP = TP workbench					Code l=1359 mm	Code l=1582 mm
	1000	1200	1500	1800	2000		
1 x M750		TP				900 49 001P	900 49 002P
1 x M900	TP	TP				901 49 001P	901 49 002P
2 x M500						902 49 001P	902 49 002P
2 x M750			TP			903 49 001P	903 49 002P
2 x M900				TP		904 49 001P	904 49 002P
3 x M500						905 49 001P	905 49 002P
4 x M500						906 49 001P	906 49 002P

Load capacity 100 kg / module spacing. Upright tube modules include 5 pcs of cable clips for easy cable management.

CC cable clip set CC5

Name	Suitable for	Code
Cable clip set (incl. 5 pcs)	Upright tubes	CC5

For easy cable management, suitable for up to five cables.



CC cable clip set CC5

TP upright frame with bench top

TP upright frame with bench top is a lighter version of the TP workbench. In addition to the bench top attached to the frame, it can be equipped with any of the Concept accessories. It's ideal for lighter use, when some additional workspace is needed.

TP upright frame

Size W x H mm	Max load kg	Code
M750 x 1500	300	123 49 005
M750 x 1850	300	123 49 006
M900 x 1500	300	123 49 007
M900 x 1850	300	123 49 008



Laminate bench top -HPL

- Light grey high pressure laminate
- Plastic edging
- Thickness 25 mm

Laminate bench top -LPL

- Light grey low pressure laminate
- Plastic edging
- Thickness 25 mm

ESD bench top

- Light grey laminate surface
- Grey edging
- Thickness 25 mm
- Semi-conductive (ESD)

Bench top & brackets for TP upright frame

Size W x D mm	Max load kg	Code HPL	Code LPL	Code ESD
1200 x 600	60	TT12060-HPL	TT12060-LPL	TT12060-ESD
Corner bracket pair		860 139-49		

Packing bench TPB is a well thought-out, safe and easy all-in-one choice

This packing table adapts and grows according to your needs. You don't need to know what your business will look like in two years' time, as you can add and remove accessories as you go. Start small and add from 50 or more accessories based on your needs. TPB comes in one flat pack and is also easy to assemble. Perfect packing table option for cost-conscious users.



Read more about Treston packing benches from our separate brochure, or check the selection on page 124.





TPH workbenches

The TPH workbench already includes a pair of uprights and one shelf; composing our best selling workstation set. It has its own range of accessories, also in stock, and covering the essential, basic needs of any professional workstation.

Stepless height adjustment

The height of TPH workbenches can be steplessly adjusted from 650 to 900 mm, which makes these benches suitable for work while sitting or standing. The height adjustment of the laminate shelf is between 1080-1550 mm. Load capacity for the bench top is 300 kg and for the shelf 50 kg even load



- Standard and cost-effective workbench with one shelf
- Suitable for a wide range of tasks and environments
- Essential range of accessories for basic needs
- Steel frame with loading capacity up to 300 kg



ACCESSORIES ON PAGE 58

Essential range of accessories available for ergonomic TPH workstation.

Designing TPH workstation



- Stepless height adjustment with allen-key between 650-900 mm.
- Frames are of epoxy powder coated steel in grey RAL 7035.
- Includes a pair of uprights and one shelf

Workbench TPH

Bench size W x D mm	Shelf size W x D mm	Max load kg	Code	Code ESD
1200 x 700	1200 x 310	300	TPH712	TPH712 ESD
1500 x 700	1500 x 310	300	TPH715	TPH715 ESD
1800 x 700	1800 x 310	300	TPH718	TPH718 ESD
1500 x 900	1500 x 310	300	TPH915	TPH915 ESD
1800 x 900	1800 x 310	300	TPH918	TPH918 ESD



Laminate bench top

- 25 mm low pressure laminate
- Light grey surface
- Plastic edging



ESD bench top

- Light grey laminate surface
- Grey edging
- Thickness 25 mm
- Semi-conductive (ESD)

Lower shelf for TPH

Not enough space above the workstation? Then utilise the space below. The lower shelf for TP bench simply hangs on the horizontal bars.

Name	Size W x D mm	Max load kg	Code
Lower shelf	1080 x 500	50	AT 120TPH
Lower shelf	1380 x 500	50	AT 150TPH
Lower shelf	1680 x 500	50	AT 180TPH



Alternative lower shelf and side worktop

Please see additional shelves on page 36.



* Workbench with one H-frame pair.

Corner workbench TPH KK

A corner workbench can be used with two TPH benches (with one H-frame pair) to create a 90 ° angle setup. TPH KK unit consists of a worktop, two H-frames and a leg in the middle. Front side 565 mm.

Bench size W x D mm	Max load kg	Code	Code ESD
1100 x 1100	150	TPH707 KK	TPH707 KK ESD
1300 x 1300	150	TPH909 KK	TPH909 KK ESD



Workbench accessories



Accessories for WB

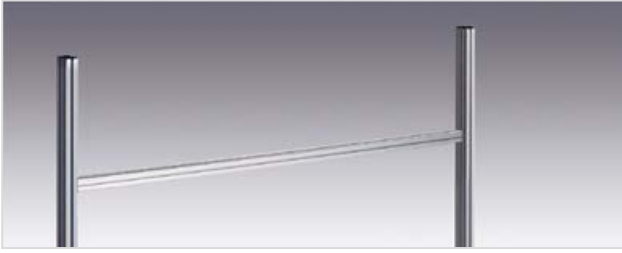

Upright profiles AL2X



Accessory frame AKK

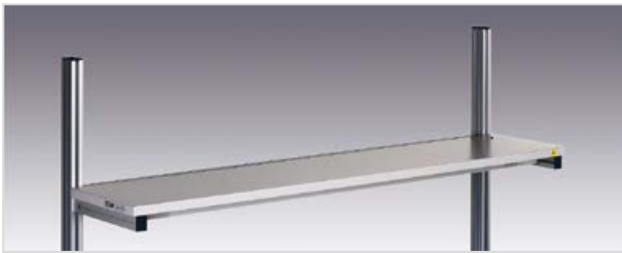

Shelf ALH



Lower shelf AT



Backstop LIST



Perforated panel ARL

Upright profiles AL2X

Size W x H mm	Suitable for	Code	Code ESD
1063 x 900	WB811	AL2X110 W	AL2X110 W
1489 x 900	WB815	AL2X150 W	AL2X150 W
1789 x 900	WB818	AL2X180 W	AL2X180 W

Needed for mounting accessories to WB benches. Includes 2 vertical and 1 horizontal profile. With 3 cable clips (CC8). Load capacity 100 kg/AL2X.

Accessory frame AKK

Size W x D mm	Suitable for	Code	Code ESD
730 x 540	AL2X150 W AL2X180 W	AKK70	AKK70
690 x 500 + 690 x 500	AL2X150 W	AKK150	AKK150
690 x 500 + 990 x 500	AL2X180 W	AKK180	AKK180

The accessory frame divides the space between the upright profiles into 2 modules. AKK frame includes 1 vertical and 1 horizontal profile. Useable height 500 mm.

Shelf ALH

Size W x D mm	Suitable for	Code	Code ESD
1073 x 310	AL2X110 W, combination AL2X180 W + AKK180	ALH110	ALH110 ESD
1500 x 310	AL2X150 W	ALH150	ALH150 ESD
1800 x 310	AL2X180 W	ALH180	ALH180 ESD

Height adjustable shelf. 25 mm laminated particle board. Load capacity 50 kg. Mount on upright profiles.

Lower shelf AT

Size W x D mm	Max load kg	Suitable for	Code	Code ESD
828 x 400	50	WB811	AT110 WB	AT110 WB ESD
1255 x 400	50	WB815	AT150 WB	AT150 WB ESD
1555 x 400	50	WB818	AT180 WB	AT180 WB ESD

Height adjustable lower shelf, 25 mm laminated particle board. Mount between the legs.

Backstop LIST

Size W x D x H mm	Suitable for	Code
1400 x 52 x 27	ALH150, AT150 WB	LIST150
1700 x 52 x 27	ALH180, AT180 WB	LIST180

Prevents items from falling off the shelf. Can be fixed on the lower shelf AT or on the shelf ALH.

Perforated panel ARL

Size W x H mm	Suitable for	Code	Code ESD
668 x 500	AKK70, AKK150	ARL70	ARL70
968 x 500	AKK180, AL2X110W	ARL100	ARL100

Mount on accessory frame AKK. The size of the perforation is 9 x 9 mm, center to center 38 mm.

Divider hoops PDH

Height mm	Suitable for	Code	Code ESD
400	ALH	PDH	PDH

Used in combination with shelf ALH. Comes in sets of 5.



Divider hoops PDH

Adjustable shelf ASH

Size W x D mm	Suitable for	Code	Code ESD
660 x 400	AKK70, AKK150, AKK180	ASH70	ASH70 ESD
960 x 400	AKK180, AL2X110W	ASH100	ASH100 ESD

Continuous adjustment for depth, height and angle. Shelf of 25 mm laminated particle board. Lipped front edge. Load capacity 35 kg static load. Mount on accessory frame AKK.

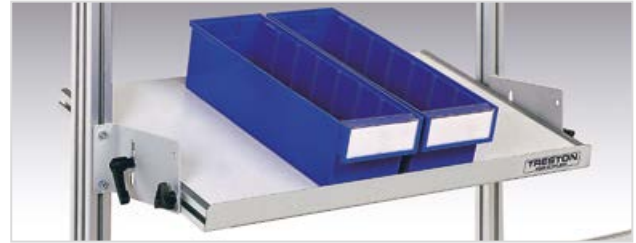

Adjustable shelf ASH

Bin profile BP

Length mm	Suitable for	Code	Code ESD
685	AKK 70, AKK150, AKK180	BP70	BP70 ESD
985	AKK180, AL2X110W	BP100	BP100 ESD

Aluminium profile for stacking and picking bins. Mount on accessory frame AKK.



Bin profile BP

Auxiliary steel shelf ASSA

Size W x D x H mm	Suitable for	Code
217 x 298 x 20	BP	ASSA4

Shelf for A4 paper and tape dispensers (max 2 pcs per shelf). Mounted on bin profile. Max load 3 kg.



Auxiliary steel shelf ASSA

Swivel arm with tray AKV

Size W x D mm	Suitable for	Code	Code ESD
460 x 210 (tray)	AL2X upright profiles	AKV400	AKV400 ESD

Lockable, angle adjustable steel tray with swivel radius of 360°. Length of swivel arm 590 mm. Max. load 15 kg.



Swivel arm with tray AKV

Component rack EPL

Size W x D x H mm	Suitable for	Shelves number	Code ESD
455 x 200 x 290	AKV	3	EPL12 ESD

Rack with three fixed shelves. Semiconductive epoxy powder coated steel in light grey (RAL 7035). Bins ordered separately, page 54. Component rack holds: 12 stacking bins 1015-4ESD or 12 picking bins 30-1L-4ESD or 6 picking bins 30-2L-4ESD or 6 picking bins 30-23L-4ESD.



Component rack EPL

Document stand WDA

Size W x H mm	Suitable for	Code	Code ESD
440 x 300	AL2X upright profiles	WDA	WDA ESD

Document stand A3 with swivel arm. Epoxy powder coated steel: light grey. Arm length 220 mm. Tilt 75°.



Document stand WDA



Bottle holder CH

Bottle holder CH

Size W x D x H mm	Ø mm	Suitable for	Code	Code ESD
110 x 105 x 120	80	AL2X upright profiles	CH	CH

Practical holder for bottle or cup. Made of black polypropylene.



Recycling material bin PRMB



Recycling material bin PRMB3

Recycling material bin PRMB

Size W x D x H mm	Suitable for	Code
282 x 590 x 600	WB, TP, TPH, TPB benches	PRMB

The 60 ltr bin with steel brackets has a maximum load of 15 kg and can be positioned on either side of the bench.

Size W x D x H mm	Suitable for	Code
282 x 590 x 650	WB, Concept, TP, TPH, TPB	PRMB3

This pull-out model with steel rails is fixed under the worktop. Bin 60 ltr. Max load 15 kg.



Tool holder box PPH

Tool holder box PPH

Size W x D x H mm	Suitable for	Code
400 x 300 x 140	WB, TP, TPH, Concept, TPB, LMT and TowerLine	PPH TXL

PPH TXL with two blue plastic bins type 3020.



Tool tray PTH

Tool tray PTH

Size W x D mm	Suitable for	Code
1000 x 60	WB benches and Concept motor benches.	PTH100

The tool tray guarantees a clean working space, while tools are close to hand.



Support bracket HSB

Support bracket HSB

Length mm	Suitable for	Code	Code ESD
1073	AL2X110 W	HSB110	HSB110
1500	AL2X150 W	HSB150	HSB150
1800	AL2X180 W	HSB180	HSB180

Support bracket of steel for suspending power tools and lighting units. Mount on upright profiles.



Cable tidy WBCT

Cable tidy WBCT

Size W x D x H mm	Suitable for	Code	Code ESD
948 x 64 x 204	WB811	WBCT110	WBCT110
1375 x 64 x 204	WB815	WBCT150	WBCT150
1675 x 64 x 204	WB818	WBCT180	WBCT180

Mount on leg frame. A cable tidy is standard equipment on WB C and WB EL models.



Cable clip set CC

Cable clip set CC

Set	Suitable for	Code	Code ESD
5 pieces	AL2X upright profiles	CC8	CC8

The cable clip set will hold cables etc. securely and neatly in place along the bench frame. The clips locate in the 8 mm profile slot.



Keyboard shelf WKA

Keyboard shelf WKA

Size W x D mm	Suitable for	Code	Code ESD
500 x 220 (shelf)	AL2X upright profiles	WKA	WKA ESD

Keyboard shelf with swivel arm. Epoxy powder coated steel. Load capacity 15 kg. Arm length 220 mm.

PC stand CPU

Width	Height	Suitable for	Code
130-240 mm	395-500 mm	WB and TP/TPH benches SAP, CTR, WTR trolleys	CPU
340-460 mm	180-285 mm		

An adjustable holder for either vertical or horizontal CPU, to mount underneath the table worktop.



PC stand CPU

LCD bracket MH

Max load kg	Suitable for	Code
15	AL2X upright profiles	MH

The quick-release mechanism is equipped with the standard used flat-screen mount 75 x 75 and 100 x 100 for the mounting of all normal flat-screens.



LCD bracket MH

LCD swivel arm MA

Max load kg	Suitable for	Code
10	AL2X upright profiles	MA

The quick-release mechanism is equipped with the standard flat-screen mount 75 x 75 and 100 x 100 for the mounting of all normal flat-screens. The arm is double articulated, turns through a radius of 180° and will extend between 95-425 mm from the upright.



LCD swivel arm MA

LCD swivel arm MA2

Max load kg	Suitable for	Code
15	AL2X upright profiles	MA2

The quick-release mechanism is equipped with the standard, widely used flat-screen mount 75 x 75 and 100 x 100 for the mounting of all normal flat-screens. The arm is double articulated, turns through a radius of 180° and will extend between 95-425 mm from the upright.



LCD swivel arm MA2

LCD screen holder with height adjustable arm MA3

Max load kg	Suitable for	Code
3-8 kg	AL2X upright profiles	MA3

Highly ergonomic and easily height adjustable monitor arm with a gas spring. Easy mounting of the monitor with a quick-release mechanism, standard flat screen mount 75 x 75 mm and 100 x 100 mm for LCD screens. Cable management by cable clips, 2 pcs included. The double arm turns through a radius of 180 and will extend between 65-515 mm from the upright.



LCD screen holder MA3

Tablet bracket MY

Suitable for	Code
MH, MA or MA2	MY

For 7-10" tablets. Requires either an MH, MA or MA2 swivel arm.



Tablet bracket MY

Power channels CJK

Dims mm	Suitable for	Code
Profile 631	AL2X upright profiles	CJK70
Profile 931	AL2X upright profiles	CJK100
3 double sockets (E1) and a switch (E2)		CJK70 SET
Double socket		E1
Switch		E2
Automatic fuse 10 A		E3
Automatic fuse/earth leakage switch 10 A/30 mA		E4
Emergency-stop-switch		E5
Data connector/shielded for Cat.6 cable		E6

Can be fitted with a choice of components, ordered separately. All meet with CE requirements. 3 m cable is included. Supplied wired and ready for use. A finished CJK 70 SET includes 3 double sockets (E1) and a switch (E2). Other sets are also available.



CJK70 SET

Accessories for Concept, LMT, TowerLine and TP

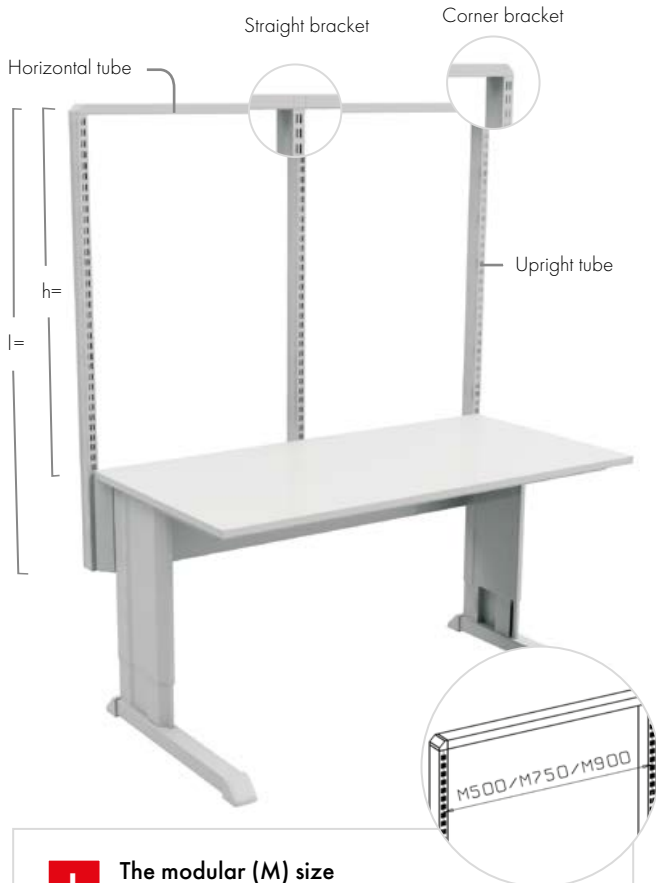

The modular (M) size

The modular (M) size refers to the distance between two upright tubes from the middle of the tube. The modular size is used to find the appropriate accessories.

Aluminium bracket

Name	Code
Aluminium bracket	846 554-00



A separate aluminium bracket can be used to attach a single tube to any bench.

CC cable clip set CC5

Name	Suitable for	Code ESD
Cable clip set (5 pcs)	Upright tubes	CC5

For easy cable management, suitable for up to five cables.

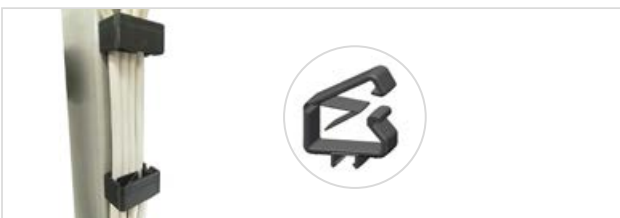

Upright tubes are the basic element for accessorising our industrial furnishings. Accessories are attached to Concept, LMT and TP benches with the aid of upright tubes or a complete, upright tube module.

The complete upright tube module includes upright tubes, corner bracket pair and straight bracket pair (if module includes more than one horizontal tube). For the Concept bench, the upright tubes are attached to the rear case of the bench. With the TP bench, you also need an accessory frame TPK (page 38). For the LMT bench, the LMT upright tube module is attached to the side of the bench.

Upright tubes for Concept and TP

Name	Size W x D mm	Length mm	Code
Upright tube	30 x 60	500	860 991-49
Upright tube	30 x 60	800	860 142-49
Upright tube	30 x 60	996	860 367-49
Upright tube	30 x 60	1359	860 024-49
Upright tube	30 x 60	1582	860 025-49
Horizontal tube	M500		860 819-49
Horizontal tube	M750		847 402-49
Horizontal tube	M900		840 104-49
Horizontal tube	M1000		854 656-49
Horizontal tube	M1200		854 655-49
Horizontal tube	M1350		850 914-49
Horizontal tube	M1500		854 654-49
Horizontal tube	M1800		854 657-49
Corner bracket pair			848 336-49
Straight bracket			851 827-49

Upright tube modules for Concept and TP

	Suitable for bench widths					Code	Code
	C = Concept					l=1359 mm	l=1582 mm
	1000	1200	1500	1800	2000	h = 1075 mm	h = 1300 mm
1 x M750 C	C/TP	C	C	C		900 49 001P	900 49 002P
1 x M900	C/TP	C/TP	C	C	C	901 49 001P	901 49 002P
2 x M500	C	C				902 49 001P	902 49 002P
2 x M750			C/TP	C	C	903 49 001P	903 49 002P
2 x M900				C/TP	C	904 49 001P	904 49 002P
3 x M500		C	C	C		905 49 001P	905 49 002P
4 x M500					C	906 49 001P	906 49 002P

h = module's height measured from Concept bench's top surface.

Upright tube modules are available also with 996 mm uprights (h=714 mm). Item codes: 90x49003P.

Load capacity 100 kg / module spacing.

Upright tube modules include 5 pcs of cable clips for easy cable management.

Upright tube modules for LMT

Module	Height, mm	Code
M1000	996	854 926-49
M1200	996	854 925-49
M1500	996	854 924-49
M1800	996	854 928-49

Light and balancer rail

Apart from the Task light and ZL3 all luminaires are fitted to light/balancer rails which are height and depth adjustable. Tool balancer rails and sliding pieces facilitate the use of heavy equipment. A tool balancer is fixed to the light/balancer rail.



Lighting solutions from page 66.

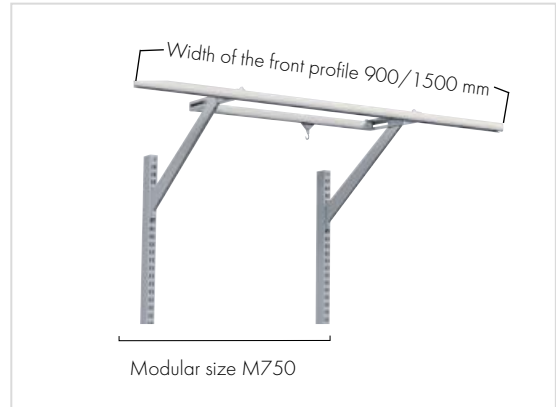
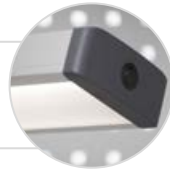

Light and balancer rail (includes one sliding piece)

Modular size	Width of the front profile mm	Max load kg	Code
2 x M500	1000	15	918 49 001P
2 x M500/1500	1500	15	918 49 002P
4 x M500	2000	15	918 49 003P
M750	750	15	918 49 004P
M750/900	900	15	918 49 013P
M750/1500	1500	15	918 49 005P
2 x M750	1500	15	918 49 006P
3 x M750	2250	15	918 49 012P
M900	900	15	918 49 007P
2 x M900	1800	15	918 49 008P
M900/1500	1500	15	918 49 009P
M1200	1200	15	918 49 010P
M1350	1350	15	918 49 011P

With extension benches you also need a center bracket, code 860 074-49

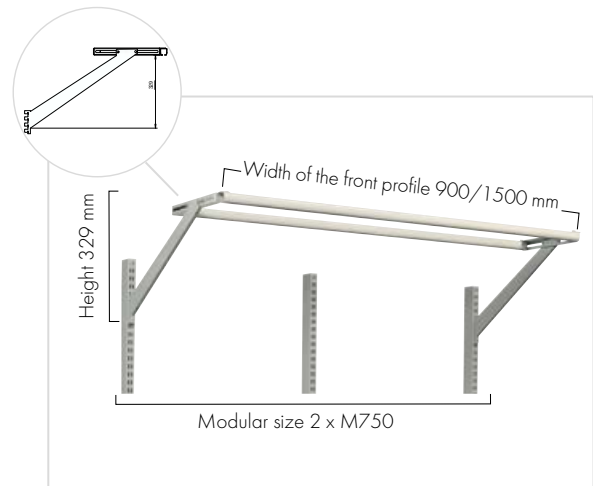

Tool balancers and other supplies

Name	Tool weight kg	Code
Tool balancer 2DU	0,5 - 1	939 502-00
Tool balancer 4DU	1 - 2	939 503-00
Sliding piece with a snap hook		890 557-51



Tool balancer



Sliding piece with a snap hook

Energy rails

Energy rails (brackets for uprights included)

Width mm fixing	Code
1 440 8 sockets + on/off switch	910 51 001 P
2 440 6 sockets + fault current protection	910 51 002 P
3 M750 6 sockets + on/off switch	911 51 002 P
M900 7 sockets + on/off switch	911 51 003 P
Bracket pair for perforated panel	853 185-51

Energy rails are available in three module sizes: M500, M750 and M900.



For UK energy rails please contact salesuk@treston.com for further details.



Power channels SJK

Dims mm	Suitable for	Code
666	Module M750	SJK75
819	Module M900	SJK90
1416	Module M1500	SJK150
1722	Module M1800	SJK180
Double socket		E1
Switch		E2
Automatic fuse 10 A		E3
Automatic fuse/earth leakage switch 10 A/30 mA		E4
Emergency-stop-switch		E5
Data connector/shielded for Cat.6 cable		E6

Can be fitted with a choice of components, ordered separately. All meet with CE requirements. 3 m cable is included. Supplied wired and ready for use.



Distributor for compressed air

Connections, Ø 8 mm	In	Out	Fixing	Code
Distributor for compressed air	1	2	vert.	859 861-00

Connectors are compatible with the CEJN 3200 series.

Can be fitted to all Treston benches.

Cable management



Hide wires and cables with a cable duct.

Cable ducts

Name	Size W x H mm	Suitable for module	Code
Cable duct	467 x 360	M500	860 808-49
Cable duct	717 x 360	M750	860 044-49
Cable duct	870 x 360	M900	860 045-49

Suitable only for Concept bench. Fitted to upright tube.

Cable ducts hide the untidy cables from other equipment. This makes it easy to keep the back of the workstation and its surroundings tidy.



Fitted to upright tubes, the horizontal cable trough enables cables to be hidden at the top of the workstation.

Cable troughs

Name	Size W x D x H mm	Suitable for module	Code
Horizontal cable trough	737 x 97 x 45	M750	854 553-49
Horizontal cable trough	890 x 97 x 45	M900	854 554-49
Horizontal cable trough	1187 x 97 x 45	M1200	854 555-49
Horizontal cable trough	1337 x 97 x 45	M1350	890 551-49
Horizontal cable trough	1487 x 97 x 45	M1500	854 556-49
Horizontal cable trough	1793 x 97 x 45	M1800	854 557-49
Vertical cable trough	52 x 62 x 1360		861 130-49

Horizontal troughs effectively conceal the cables, without preventing maintenance access.

The vertical cable trough is fitted on the side of the upright tube.

Shelves

Shelves

Name	Suitable for module	Size W x D mm	Max load kg	Code
Steel shelf	M500	490 x 300	50	860 804-49
Steel shelf	M500	490 x 400	50	860 805-49
Adjustable shelf	M500	470 x 505	100	920 49 001P
Adjustable shelf	M500	470 x 650	100	920 49 002P
Adjustable shelf, stepless depth adjustment	M500	470 x 505	50	920 49 003P
Adjustable shelf, stepless depth adjustment	M500	470 x 650	50	920 49 004P
Document shelf	M500	470 x 265	5	860 806-49
Steel shelf	M750	740 x 300	50	836 028-49
Steel shelf	M750	740 x 400	50	852 770-49
Adjustable shelf	M750	720 x 505	100	920 49 005P
Adjustable shelf	M750	720 x 650	100	920 49 006P
Adjustable shelf, stepless depth adjustment	M750	720 x 505	50	920 49 007P
Adjustable shelf, stepless depth adjustment	M750	720 x 650	50	920 49 008P
Extendable shelf	M750	720 x 390	30	925 49 002P
Document shelf	M750	720 x 265	5	860 115-49
Steel shelf	M900	890 x 300	50	852 283-49
Steel shelf	M900	890 x 400	50	852 769-49
Adjustable shelf	M900	870 x 505	100	920 49 009P
Adjustable shelf	M900	870 x 650	100	920 49 010P
Adjustable shelf, stepless depth adjustment	M900	870 x 505	50	920 49 011P
Adjustable shelf, stepless depth adjustment	M900	870 x 650	50	920 49 012P
Extendable shelf	M900	870 x 390	30	925 49 003P
Document shelf	M900	870 x 265	5	860 399-49
Steel shelf	M1000	967 x 300	80	854 494-49
Steel shelf	M1000	967 x 400	80	854 495-49
Steel shelf	M1200	1167 x 300	80	854 480-49
Steel shelf	M1200	1167 x 400	80	854 483-49
Steel shelf	M1350	1340 x 300	50	860 787-49
Steel shelf	M1350	1340 x 400	50	860 788-49
Adjustable shelf	M1350	1320 x 505	100	920 49 013P
Adjustable shelf	M1350	1320 x 650	100	920 49 014P
Steel shelf	M1500	1467 x 300	80	854 481-49
Steel shelf	M1500	1467 x 400	80	854 484-49
Steel shelf	M1800	1773 x 300	80	854 482-49
Steel shelf	M1800	1773 x 400	80	854 485-49
Corner shelf		1318 x 400	80	854 479-49



Adjustable shelves are also available as non ESD-versions (code 41 instead of 49).

Divider pair for shelves

Name	Suitable for shelves	Size D x H mm	Code
Divider pair	M500, M750, M900, M1350	285 x 190	010 004-49
Divider pair	M500, M750, M900, M1350	385 x 190	010 005-49
Divider pair	M1000, M1200, M1500, M1800	285 x 190	861 116-49



Steel shelf M500, M750, M900, M1350



Steel shelf M1000, M1200, M1500, M1800



Adjustable shelf, tilting 0-25°



Steplessly adjustable shelf, tilting 0-25°



Extendable shelf, tilting 0-25°



Document shelf, tilting 10-75°



Divider pair for shelves



Adjustable auxiliary shelf



Laptop/printer shelf with arm



LCD-holder & keyboard tray

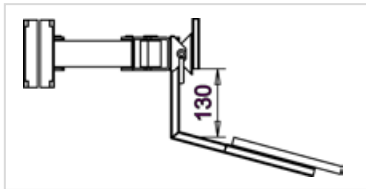

Maximum distance between the LCD holder and keyboard tray



Holder for Thin Client PC



Keyboard tray



Document holder



Double arm

Adjustable auxiliary shelf

Name	Size W x D mm	Tilting	Max load kg	Code	Code ESD
Adjustable auxiliary shelf	560 x 340	0-25°	15	927 41 001P	927 49 001P
Adjustable auxiliary shelf	605 x 405	0-25°	15	927 41 002P	927 49 002P

IT shelves and trays

Name	Size W x D x H mm	Max load kg	Code
Laptop / printer shelf	365 x 365	25	930 49 001P
Keyboard tray for laptop shelf	480 x 270	5	860 904-49
Keyboard and mouse tray for laptop shelf	620 x 270	5	860 903-49
LCD holder with double arm		15	930 49 002P
Keyboard tray for LCD holder	480 x 260	5	860 941-49
Keyboard and mouse tray for LCD holder	620 x 260	5	860 942-49
Holder for Thin Client PC (fixed to keyboard tray 860941-49 or 860942-49)	250 x 45-65 x 145	5	TCH
Keyboard tray (attached to the bench top)**	680 x 375 x 106 (outer) 620 x 305 x 90 (inner)	10	925 49 001P

** Suitable also for VWB, TP, TPH and TPB benches.

Document holders

Name	Size W x D mm	Max load kg	Code
Document holder A4	290 x 330	5	928 49 008P
Document holder A3	418 x 330	5	928 49 009P

Replacement arms (spare parts)

Name	Length mm	Max load kg	Code
Double arm, 40 mm	200+200	10	880 020-49
Double arm, 60 mm	200+200	15	880 010-49
Heavy arm, 60 mm	287+221	30	860 993-49
Height-adjustable arm with gas spring, 60 mm (height adjustment range 165 mm)	375	15	860 985-49
Height-adjustable profile	55 x 80 x 590	15	860 997-49



TowerLine arm holders

Arm holders are needed with TowerLine benches for accessories with 40 mm / 60 mm arms. TowerLine arm holder for 60 mm arm, code 861 099-49. TowerLine arm holder for 40 mm arm, code 861 098-49.



Heavy arm



Height-adjustable arm



Height-adjustable profile

When a position changes, the height must be adjusted

Frequent changes in the working position, such as changing from a sitting position to a standing position, require height-adjustable arm (860 985-49). The height-adjustable profile (860 997-49) can be attached to any rack with arm (such as the PC rack) that is pulled down and lifted back up according to the working position. The adjustment range is 450 mm.

Trays

Name	Size W x D mm	Max load kg	Code
Equipment tray	250 x 250 x 90	10	928 49 001P
Equipment tray	500 x 250 x 125	15	928 49 002P
Equipment tray *	500 x 250 x 125	30	928 49 003P
Bin shelf	560 x 175 x 125	15	928 49 005P
Bin shelf	600 x 220 x 125	15	928 49 006P
Stand for picking bins**	560 x 165 x 355		860 113-49

* Comes with heavy arm.

** Space for 15 picking bins 30-1L-4ESD



1. Adapter set AS2



2. Adapter set AS3

Adapter set AS

Name	Suitable for	Code
Adapter set for upright profiles*	MH / MA / MA2	AS2
	MA3	AS3

* Concept/TP/LMT/Towerline upright tube profiles and TPH C-profile

The above adapter sets are needed for fixing MH/MA/MA2/MA3 arms to the uprights.

LCD bracket MH

Name	Max load kg	Suitable for	Code
LCD bracket MH	15	Upright profiles	MH

The quick-release mechanism is equipped with the standard used flat-screen mount 75 x 75 and 100 x 100 for the mounting of all normal flat-screens.

LCD swivel arm MA

Name	Max load kg	Suitable for	Code
LCD swivel arm MA	10	Upright profiles	MA

The quick-release mechanism is equipped with the standard flat-screen mount 75 x 75 and 100 x 100 for the mounting of all normal flat-screens. The arm is double articulated, turns through a radius of 180° and will extend between 95-425 mm from the upright.

LCD swivel arm MA2

Name	Max load kg	Suitable for	Code
LCD swivel arm MA2	15	Upright profiles	MA2

The quick-release mechanism is equipped with the standard, widely used flat-screen mount 75 x 75 and 100 x 100 for the mounting of all normal flat-screens. The arm is double articulated, turns through a radius of 180° and will extend between 95-425 mm from the upright.

LCD screen holder with height adjustable arm MA3

Name	Max load kg	Suitable for	Code
LCD screen holder MA3	3-8	Upright profiles	MA3

Highly ergonomic and easily height adjustable monitor arm with a gas spring. Easy mounting of the monitor with a quick-release mechanism, standard flat screen mount 75 x 75 mm and 100 x 100 mm for LCD screens. Cable management by cable clips, 2 pcs included. The double arm turns through a radius of 180 and will extend between 65-515 mm from the upright.



Equipment tray



Bin shelf



Stand for stacking bins



LCD bracket MH



LCD swivel arm MA



LCD swivel arm MA2



LCD screen holder MA3



Curved bin rail with arm



Extension for curved bin rail with arm

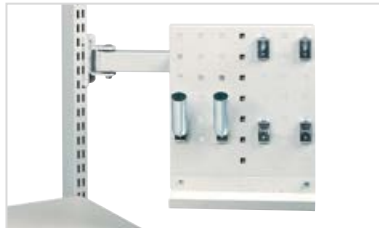

Tool panel

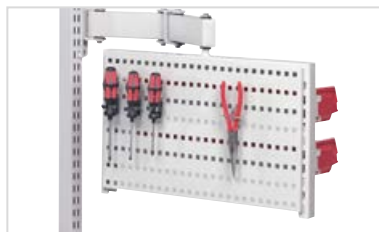

Rotating tool panel with perforated panel and R-hooks



Rotating tool panel with M500 perforated panel, M500 bin rails and 8 plastic ESD bins



Rotating tool panel with M500 perforated panel, aluminium bin rail M500 and auxiliary steel shelf



Auxiliary top

Bin rails with arms

Name	Size W x D mm	Max load kg	Code
Curved bin rail with arm	770 x 54	15	929 49 002P
Extension for curved bin rail with arm	770 x 54		860 911-49

Tool panel

Name	Size W x D mm	Max load kg	Code
Tool panel	267 x 305	5	928 49 010P

Rotating tool panels

Name	Size W x D mm	Max load kg	Code
Rotating tool panel, height-adjustable arm	513 x 320	15	860 864-49P
Rotating tool panel, double arm	513 x 320	15	880 865-49P
Perforated panel	470 x 300		860 951-49
Tool trough M500	470 x 150		860 952-49
Bin rail M500	492 x 90	15*	859 150-49
Light bin rail M500	492 x 54	10	860 953-49
Aluminium bin rail M500 for rotating tool panel	486 x 55 x 75	15	BP500C
Auxiliary steel shelf	217 x 298 x 20	3	ASSA4

*Actual bin rail max load 40 kg but with arm 15 kg.



Rotating tool panel

The rotating tool panel can be equipped with perforated panels and tool troughs. The rotating tool panel is compatible with all M500 accessories, such as the tool trough and the bin rails.



Plastic bins, hooks and tools in pictures are not included.

Auxiliary top, fixed brackets

Name	Size W x D mm	Max load kg	Code	Code ESD
Auxiliary top left	400 x 500	40	926 41 001P	926 49 001P
Auxiliary top right	400 x 500	40	926 41 002P	926 49 002P

Other supplies

Name	Code
Bottle holder (Ø 100) for upright tube	859 063-49
Roll holder for upright tube (roll ø height 150 mm, width 320 mm)	860 841-49



Bottle holder



Roll holder

Small storage solutions

Name	Module size	Size W x D x H mm	Max load kg	Code
Perforated tool cabinet, blue	M500	470 x 250 x 600	20	854 039-07
Perforated tool cabinet, blue	M750	720 x 255 x 900	60	852 629-07
Shelf for M750 perforated tool cabinet		715 x 175 x 15	10	836 273-49
Sliding door cabinet	M750	720 x 370 x 400	40	860 970-49
File cabinet with two shelves	M750	720 x 330 x 900	60	860 980-49
Personal safety equipment cabinet	M750	720 x 330 x 900	60	860 987-07
PC/folder box, fitted to the upright tubes		130 x 290 x 330	5	860 983-49



Perforated tool cabinet



Sliding door cabinet



File cabinet with two shelves



Personal safety equipment cabinet



PC/folder box

Stacking bins and shelf bins

Another way of ensuring an ergonomic working position and saving space is to use bin rails. The higher the rails are, the further they are from the workstation. To ensure an ergonomic working position, use the extension bracket pair on the higher rails. The bin rails are available in six standard module sizes.

Name	Suitable for module	Size W x D mm	Max load kg	Code
Bin rail	M500	492 x 100	50	859 150-49
Light bin rail *	M500	492 x 54	10	860 953-49
Bin rail	M750	742 x 100	50	859 151-49
Light bin rail *	M750	742 x 54	10	860 955-49
Bin rail	M900	895 x 100	50	859 152-49
Light bin rail *	M900	895 x 54	10	860 956-49
Bin rail	M1000	967 x 100	50	859 156-49
Bin rail	M1200	1167 x 100	50	859 157-49
Bin rail	M1350	1343 x 100	50	859 153-49
Bin rail	M1500	1493 x 100	50	859 154-49
Bin rail	M1800	1799 x 100	50	859 155-49
Extension bracket pair	60		50	860 919-49
Aluminium bin rail M500		486 x 55 x 75	40	BP500C
Aluminium bin rail M750		736 x 55 x 75	40	BP750C
Aluminium bin rail M900		889 x 55 x 75	40	BP900C
Aluminium bin rail M1500		1486 x 55 x 75	40	BP1500C
Aluminium bin rail M1800		1792 x 55 x 75	40	BP1800C
Auxiliary steel shelf		217 x 298 x 20	3	ASSA4

* Suitable only for picking bins 30-1L, 30-2L and 30-23L.



Bin rail with stacking bins.



Light bin rail with stacking bins.



Aluminium bin rail BP and ASSA4



Stacking bins

No.	Capacity l	Outer dims W x D x H mm	Inner dims W x D x H mm	Pack pcs	Labels and cross dividers			Labels + shields	Pack min. order	Cross divider	Pack pcs
					Code.* blue	Code.* red	Code.* ESD black				
1.	1,0	105 x 165 x 75	90 x 105 x 65	60	1015-6	1015-5	1015-4 ESD	E10	60		
2.	3,6	149 x 250 x 130	125 x 185 x 115	30	1525-6	1525-5	1525-4 ESD	E15	30	V-14	30
3.	6,5	186 x 300 x 156	155 x 230 x 140	24	1930-6	1930-5	1930-4 ESD	E20	24	V-19	24
4.	8,7	186 x 400 x 156	155 x 330 x 140	24	1940-6	1940-5	1940-4 ESD	E20	24	V-19	24
5.	1,0	99 x 160 x 70	85 x 100 x 62	60	30-1L-6		30-1L-4 ESD				
6.	1,7	198 x 160 x 70	175 x 100 x 62	30	30-2L-6		30-2L-4 ESD				
7.	1,7	198 x 160 x 70	175 x 100 x 62 (2 fixed length dividers)	30	30-23L-6		30-23L-4 ESD				

*) Order number/one item. All bins are also available in grey colour, colour code -3

Fixing stacking bins on the bin rail

Bin rail	M500	M750	M900	M1350	M1500	M1800	Curved bin rail
1015	4	7	8	12	14	17	
1525	3	5	6	9	10	12	
1930 & 1940	2	4	4	7	8	9	
30-1L	5	7	9	13	15	17	5
30-2L & 30-23L	2	3	4	7	7	9	



Shelf bins

No.	Capacity l	Outer dims W x D x H mm	Inner dims W x D x H mm	Pack pcs	Cross dividers			Code.*	Number/bin
					Code.* blue	Code.* red	Code.* ESD black		
1.	1,9	92 x 400 x 82	75 x 357 x 70	30	4010-6	4010-5	4010-4 ESD	D-10	6
2.	2,4	92 x 500 x 82	75 x 457 x 70	30	5010-6	5010-5	5010-4 ESD	D-10	8
3.	4,2	186 x 400 x 82	167 x 357 x 70	15	4020-6	4020-5	4020-4 ESD	D-20	6
4.	5,3	186 x 500 x 82	167 x 457 x 70	15	5020-6	5020-5	5020-4 ESD	D-20	8
5.	6,5	186 x 600 x 82	167 x 557 x 70	15	6020-6	6020-5	6020-4 ESD	D-20	10

*) Order number/one items. All bins are also available in grey colour, colour code -3

Other supplies

Name	Description	Size W x D x H mm	Code
Stacking bin set	Four bins made of blue polypropylene (PP).	2 pcs 230 x 155 x 140 2 pcs 185 x 125 x 115	SBS4
Tool holder box	With two blue plastic bins type 3020.	400 x 300 x 150	PPH TXL



Stacking bin set



Please see our wide bin selection in Storage Systems brochure.



Tool holder box

treston.com/catalogues/storage-systems/

CPU cabinets and holders

Name	Size W x D x H mm	Max load kg	Suitable for	Code
1. CPU/printer holder, bar clamp	>150 x 500 x 85	20	Concept with accessory bar	860 551-49
2. CPU holder	180-225 x 450 x 50	20	Concept (allen key and hand crank)	860 552-49
2. CPU holder	180-225 x 450 x 50	20	Concept motor, LMT, TowerLine	860 740-49
3. CPU holder	180-225 x 450 x 50	20	TP upright frame	860 553-49
4. CPU holder	180-225 x 450 x 50	20	TP/TPH benches	854 440-49
5. CPU cabinet *	325 x 550 x 560	40	Concept benches	861 120-49
6. Tool cabinet *	325 x 525 x 560	40	Concept benches	861 121-49

*Fixed under bench top, fastening set for Concept bench see page 98 (same as fastening set for drawer unit 45).



1. CPU/printer holder, bar clamp



2. CPU holder



3. CPU holder



4. CPU holder



5. CPU cabinet



6. Tool cabinet

Footrests

Name	Size W x D mm	Height	Tilting	Suitable for	Code	Code ESD
Footrest, floor	550 x 350	100	5-30	All benches		860 947-49
Footrest, floor, height adjustable	550 x 350	90-280	5-30	All benches		860 137-49
Footrest, floor, with gas action	550 x 350	90-260	5-30	All benches		860 224-49
Footrest JT2*	500 x 370	100		All benches	JT2	JT2 ESD
Footrest, bar	550 x 350	90-280	5-30	Concept		860 136-49
Footrest, bar, with gas action	550 x 350	90-260	5-30	Concept		860 196-49

*The feature of this foot rest is the fluted exercise roller which revitalises the feet while working. The surface is corrugated to prevent slipping. Colour grey. Material polystyrene.



Footrest, floor



Footrest, floor, height adjustable



Footrest, floor, with gas action



Footrest JT2



Footrest, bar

Accessory bars

Name	Bench frame width mm	Depth adjustment mm	Code
Accessory bar Concept	1000	-	860 084-49
Accessory bar Concept	1200	-	860 085-49
Accessory bar Concept	1500	150	860 088-49
Accessory bar Concept	1500	-	860 086-49
Accessory bar Concept	1800	150	860 089-49
Accessory bar Concept	1800	-	860 083-49
Accessory bar Concept	2000	150	860 090-49

The accessory bar can be used to fix a footrest or a CPU/printer holder. The accessory bar is included with the hand crank and motor adjustable Concept benches.



Footrest, bar, with gas action

Accessories for TPH

All TPH accessories are suitable also for TPB benches



Metal shelf TH

Metal shelf TH

Size W x D mm	Max load kg	Suitable for	Code	Code ESD
1119 x 145	30	TPH712	TH120	TH120 ESD
1419 x 145	30	TPH715/ 915, TPB915	TH150	TH150 ESD
1719 x 145	30	TPH718/ 918, TPB918	TH180	TH180 ESD

Adjustment for depth, height and angle. For stacking and picking bins. Load capacity 30 kg.



Bin profile BP

Bin profile BP

Width mm	Max load kg	Suitable for	Code	Code ESD
profile 1115	15	TPH712	BP120	BP120 ESD
profile 1415	15	TPH715/ 915, TPB915	BP150	BP150 ESD
profile 1715	15	TPH718/ 918, TPB918	BP180	BP180 ESD

Aluminium profile for stacking and picking bins.



Auxiliary steel shelf ASSA

Auxiliary steel shelf ASSA

Size W x D x H mm	Suitable for	Code
217 x 298 x 20	BP	ASSA4

Shelf for A4 paper and tape dispensers (max 2 pcs per shelf). Mounted on bin profile. Max load 3 kg.



Stacking bin set SBS4

Stacking bin set SBS4

Size W x D x H mm	Suitable for	Code
2 pcs 230 x 155 x 140	BP	SBS4
2 pcs 185 x 125 x 115		

Four bins made of blue polypropylene (PP).



Auxiliary shelf SH

Auxiliary shelf SH

Size W x D mm	Max load kg	Suitable for	Code	Code ESD
1200 x 310	50	TPH712	SH120	SH120 ESD
1500 x 310	50	TPH715/ 915	SH150	SH150 ESD
1800 x 310	50	TPH718/ 918	SH180	SH180 ESD

Height adjustable shelf. 25 mm laminated particle board.



Backstop LIST

Backstop LIST

Size W x D x H mm	Suitable for	Code
1400 x 52 x 27	LIST 150: AT 150TPH, SH150	LIST150
1700 x 52 x 27	LIST180: AT 180TPH, SH180	LIST180

Prevents items from falling off the shelf. Can be fixed on the lower shelf AT or on the shelf ALH.

Tool and lighting support KT

Size W x D mm	Suitable for	Code	Code ESD
1200 x 600	TPH712	KT120	KT120
1500 x 600	TPH715/915 and TPB915	KT150	KT150
1800 x 600	TPH718/918 and TPB180	KT180	KT180
Extra C-profile 1500	KT150	SPR150	SPR150
Extra C-profile 1800	KT180	SPR180	SPR180

For suspending power tools and lighting units. Includes one C-profile bar with sliding hook.



Upright profiles HKCP

Height mm	Suitable for	Code	Code ESD
1470	TPH, TPB	HKCP147	HKCP147

If you mount both perforated panel RL and cable channel TJK to TPH benches, you must order extra-high upright profiles.



Upright profiles HKCP

Swivel arm with tray CKV

Size W x D mm	Max load kg	Suitable for	Code	Code ESD
Tray 210 x 460	15	TPH, TPB	CKV400	CKV400 ESD

Swivel arm with lockable, angle adjustable steel tray. Load 15 kg. Mount on C-profile.



Swivel arm with tray CKV

Component rack EPL

Size W x D x H mm	Suitable for	Shelves number	Code ESD
455 x 200 x 290	CKV	3	EPL12 ESD

Rack with three fixed shelves. Of semiconductive epoxy powder coated steel in light grey (RAL 7035).



Component rack EPL

Tool holder box PPH

Size W x D x H mm	Suitable for	Code
400 x 300 x 140	All benches	PPH TXL

PPH TXL with two blue plastic bins type 3020.



Tool holder box PPH

Recycling material bin PRMB

Size W x D x H mm	Suitable for	Code
530 x 280 x 585	WB, TP, TPH, TPB benches	PRMB

The 60 ltr bin with steel brackets has a maximum load of 15 kg and can be positioned on either side or rear of the bench.

286 x 570 x 650 WB, Concept, TP, TPH and TPB PRMB3

This pull-out model with steel rails is fixed under the worktop. Bin 60 ltr. Max load 15 kg.



Recycling material bin PRMB



Recycling material bin PRMB3



LCD bracket MH



LCD swivel arm MA



LCD swivel arm MA2



LCD screen holder MA3



Tablet bracket MY



CPU holder

LCD bracket MH

Max load kg	Suitable for	Code
15	WB/TPH benches and WTR trolley	MH

The quick-release mechanism is equipped with the standard used flat-screen mount 75 x 75 and 100 x 100 for the mounting of all normal flat-screens. Divider set AS2 is needed for mounting LCD bracket MH to TPH benches, ordered separately.

LCD swivel arm MA

Max load kg	Suitable for	Code
10	WB/TPH benches and WTR trolley	MA

The quick-release mechanism is equipped with the standard flat-screen mount 75 x 75 and 100 x 100 for the mounting of all normal flat-screens. The arm is double articulated, turns through a radius of 180° and will extend between 95-425 mm from the upright. Divider set AS2 is needed for mounting LCD swivel arm MA to TPH benches, ordered separately.

LCD swivel arm MA2

Max load kg	Suitable for	Code
15	WB/TPH benches and WTR trolley	MA2

The quick-release mechanism is equipped with the standard, widely used flat-screen mount 75 x 75 and 100 x 100 for the mounting of all normal flatscreens. The arm is double articulated, turns through a radius of 180° and will extend between 95-425 mm from the upright. Divider set AS2 is needed for mounting LCD swivel arm MA2 to TPH benches, ordered separately.

LCD screen holder with height adjustable arm MA3

Max load kg	Suitable for	Code
3-8	TPH benches	MA3

Highly ergonomic and easily height adjustable monitor arm with a gas spring. Easy mounting of the monitor with a quick-release mechanism, standard flat screen mount 75 x 75 and 100 x 100 for LCD screens. Cable management by cable clips, 2 pcs included. The double arm turns through a radius of 180 and will extend between 65-515 mm from the upright. Divider set AS3 is needed for mounting LCD swivel arm MA3 to TPH benches, ordered separately.

Adapter set AS

Suitable for	Code
MH / MA / MA2	AS2
MA3	AS3

The above adapter sets are needed for fixing MH/MA/MA2/MA3 arms to the TPH C-profiles

Tablet bracket MY

Suitable for	Code
MH, MA or MA2	MY

For 7-10" tablets. Requires either an MH, MA or MA2 swivel arm.

CPU holder

Size W x D x H mm	Max load kg	Suitable for	Code
180-225 x 450 x 50	20	TP/TPH benches	854 440-49

Cable tidy TPHCT

Size W x D x H mm	Suitable for	Code	Code ESD
1115 x 45 x 205	TPH712	TPHCT120	TPHCT120
1415 x 45 x 205	TPH715/ 915	TPHCT150	TPHCT150
1715 x 45 x 205	TPH718/ 918	TPHCT180	TPHCT180

Mounted between C-profiles below worktop. Of perforated epoxy powder coated steel.

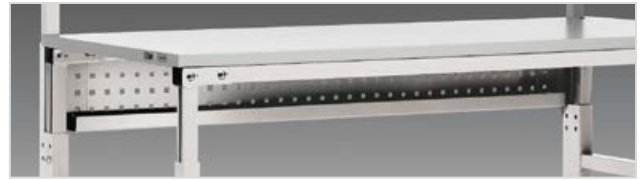

Cable tidy TPHCT

Perforated panel RL

Size W x H mm	Suitable for	Code	Code ESD
1115 x 750	TPH712	RL120	RL120
1415 x 750	TPH715/ 915	RL150	RL150
1715 x 750	TPH718/ 918	RL180	RL180
Connector set for RL perforated panels	TPH	RK1	RK1

Robust, perforated steel panel. 9 mm perforations at 38 mm centres. Mount on TPH-benches with connectors RK 1. Can also be attached to a wall with screws (included).

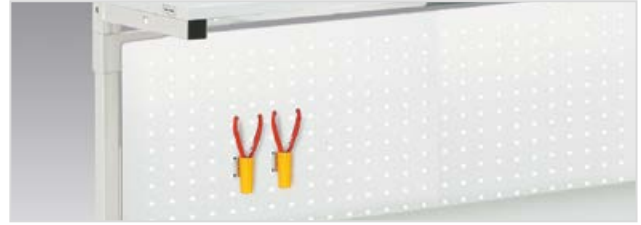

Perforated panel RL

Cable clip set CC

Set	Max load kg	Suitable for	Code	Code ESD
5 pcs/set	15	TPH, TBP	CC12	CC 12

The cable clip set will hold cables etc. securely and neatly in place along the bench frame. The clips locate in the 12 mm profile slot.



Cable clip set CC

Power channels for TPH/TPB

Constructed from aluminium profile, this range of compact power channels provides power distribution for TPH benches. Pre-assembled with a choice of components, ordered separately. The power channel is isolated from the workbench. 3 m cable is included. Aluminium profile 72 x 72 mm. All meet with CE requirements.

Dims mm	Suitable for	Code
Profile 1058	TPH712	TJK120
Profile 1358	TPH715/ 915	TJK150
Profile 1658	TPH718/ 918	TJK180
Includes 3 x E1, E2	TPH715/ 915	TJK150 SET
Includes 3 x E1, E2	TPH718/ 918	TJK180 SET
Includes 1x E1, 1 x E2	TPH712	TJK120 SET2
Includes 1x E1, 1 x E2	TPH715/ 915	TJK150 SET2
Includes 1x E1, 1 x E2	TPH718/ 918	TJK180 SET2
Double socket		E1
Switch		E2
Automatic fuse 10 A		E3
Automatic fuse/earth leakage switch 10 A/30 mA		E4
Emergency-stop-switch		E5
Data connector/shielded for Cat.6 cable		E6

The finished TJK150 SET and TJK180 SET include 3 double sockets (E1) and a switch (E2). The finished TJK120 SET2, TJK150 SET2 and TJK180 SET2 include 1 double socket (E1) and a switch (E2). Other SETs are also available.



Power channel TJK

Accessories that suit all benches

Accessories attached to the bench top

Name	Size W x D x H mm	Max load kg	Suitable for	Code
Equipment tray with bench top fixing	250 x 250 x 90	5	all benches	860 885-49
Document holder A4 with bench top fixing	290 x 330	5	all benches	860 882-49
Tool panel with bench top fixing	267 x 305	5	all benches	860 883-49
Bin rail with bench top fixing	315 x 72	5	all benches	860 884-49
Light arm, bench top fixing	200	5	all benches	860 990-49
Bag holder for bench top lower edge			all benches	860 840-49
Keyboard tray NT	525 x 399 x 133 (outer) 500 x 250 x 110 (inner)		WB and TP/TPH benches, SAP/WTR trolleys	NT 500 ESD
Recycling material bin PRMB3 with steel rails	282 x 590 x 650		WB, Concept, TP, TPH and TPB	PRMB3
Tool holder box PPH	400 x 300 x 140		all benches	PPH TXL
Keyboard tray (attached to the bench top)**	680 x 375 x 106 (outer) 620 x 305 x 90 (inner)	10	all benches	925 49 001P



Equipment tray



Document holder



Tool panel



Bin rail



Light arm



Bag holder



Keyboard tray NT



Recycling material bin
PRMB3 can be pulled-
out with steel rails



Tool holder box PPH

Outlet panel PRK5

Dims mm	Suitable for	Code
5 Schuco wall sockets, switch and a 3 m cable	WB and TP/TPH/TPB benches, CTR/SAP/WTR trolleys.	PRK5

Mount on upright profiles with connectors (included). Can also be attached under the laminate shelf with screws.





ESD accessories

Earthing supplies

Name	Press button	Resistance	Code
1 Earthing box	3 x 10 mm	1 Mohm	J6603
2 Earth junction box, yellow			860 522-00
3 Earthing cable, black, 1,5 m	10 mm / M5 terminal	1 Mohm	860 520-00
4 Earthing cable 5 m	10 mm		MK3040
5 Press stud	10 mm / female		PN3034

Wrist straps

Name	Press button	Resistance	Code
6 Adjustable wrist strap	7 mm	1 Mohm	R2216
7 Metal wrist strap	7 mm	1 Mohm	R2206

Wrist strap set includes wrist band and coiled cord. Earth lead with 1 megaohm resistor, length 3,6 m. Includes 7 mm press stud for connection to wrist strap and 10 mm press stud for connection to earthing point.

ESD mats

Name	Size W x D mm	Code
8 ESD Ergo floor mat	950 x 650	852 880-00
9 Bench top ESD-mats*	1,22 x 10,00 m (12,20 m ²)	PM157

*Resistant to heat, solder flux, most chemicals and solvents. The ESD mats are to EN 61340-5-1 standards. Abraded non slip underside. Does not contain PVC. Supplied by the metre or in rolls. Colour: platinum grey. Resistance surface to ground: $7,5 \times 10^5 - 10^7$ ohm.

ESD-flooring LM 9500

Name	Roll size m	Resistance	Code
10 ESD-flooring	1,5 x 25	100K ohm	LM9500

Dissipative, hard wearing vinyl flooring requiring permanent on site installation. Supplied by the metre or on rolls. Accessories: Press stud and earthing cable. Colour: grey.



TRESTON

Lighting





Lighting ergonomics



Lighting is a vital part of ergonomic workspaces in industrial environments. Light allows people to see and perform tasks better as well as affecting their personal wellbeing and health.

Individually adjustable, natural workstation lighting means more productivity

Investing in individually controllable task lighting on workstations benefits both the employees and the employer. Employees feel more motivated as they can adjust brightness and preferably also colour tone to best suit themselves and the task at hand. This can lead to increased productivity, reduced errors and less absence, which normally affect the company's profitability.

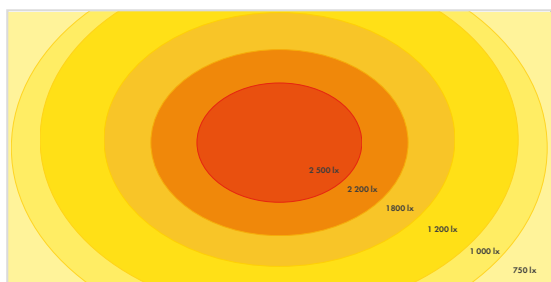

Graph of light Illuminance

Treston NaturLite LED 1200 Illuminance $\pm 10\%$ (@1 meter)

Lighting standard sets the expectations

When designing workstations and their lighting, we observe the recommendations of the EN 124641 standard on indoor workplace lighting. The illuminance levels set by standards are average values, but going beyond those is often reasonable. It is especially beneficial to increase the high-quality lighting for employees over 45 years old.

Optical ergonomics need attention

Optical ergonomics require the viewed object to be at a suitable distance and location, in order to maintain an acceptable amount of eye movement, ensuring that the details can be seen without problems. Also, adequate and glare-free lighting is important. When these conditions apply and the working position is well adjusted, saving time and money due to fewer absences and decreased stress can be expected.

Benefits of proper adjustable lighting in industrial environments include

- Increased productivity
- Reduced number of errors
- Decreased absenteeism
- Increased well-being of the employees

Treston NaturLite LED

Natural workstation lighting for industrial environments



Good, adjustable workstation lighting is essential for work quality and the well-being of employees. The right amount of light at the right time also enhances productivity and reduces errors in industrial environments.

Achieve your full potential with:

- Tunable colour tone
- Dimmable brightness
- Effective performance



Get all the specifications and download the brochure:

<http://www.treston.com/catalogues/naturlite-led.pdf>

Treston NaturLite LED Plus 1200

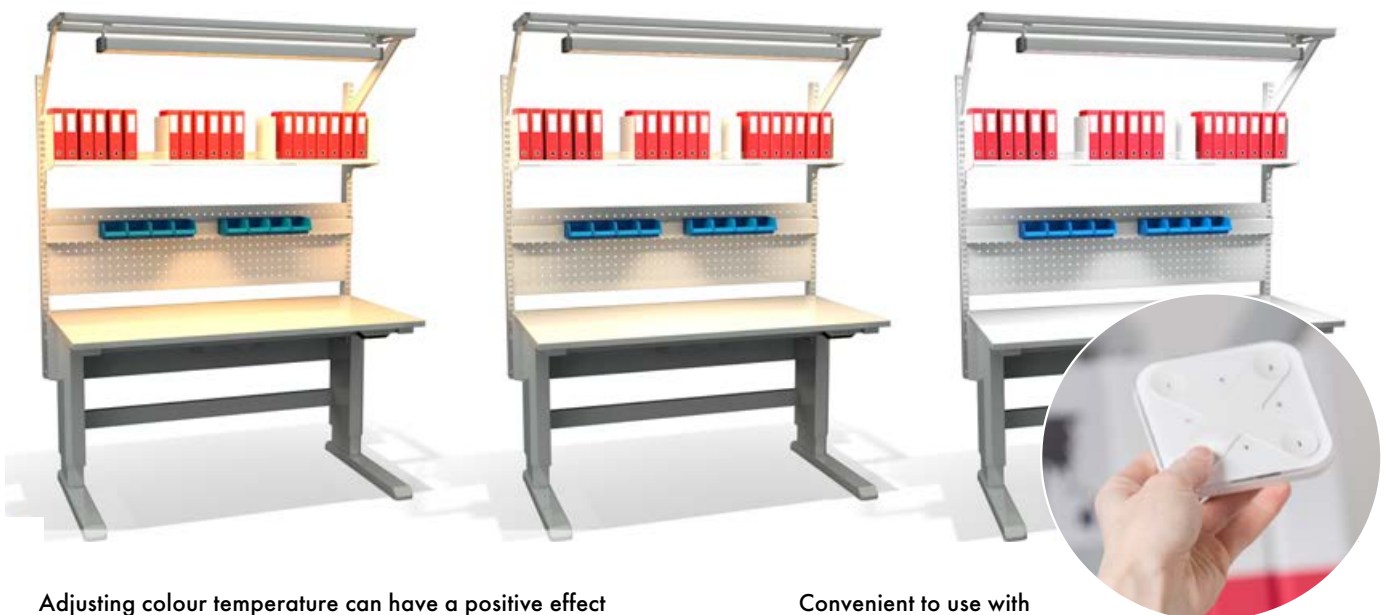

Adjusting colour temperature can have a positive effect on employee productivity and well-being. Beneficial also in environments where it is important to see objects in different light ranges.

Convenient to use with a mobile app or a remote control.

WATCH THIS ANIMATION and get the main facts of the Treston NaturLite LED lights in less than 2 minutes: <https://vimeo.com/241502723>



Dimmable
brightness

Treston's New Lighting Solution: Treston NaturLite LED



Treston NaturLite LED Plus 1200
Bright light with tunable colour tone



Treston NaturLite LED 900
Bright, dimmable light in smaller body



Treston NaturLite LED 1200
Bright light with full adjustability



Treston NaturLite LED Wing 500
Versatile task light

Name	Control	Colour temperature	Illuminance ±10% (@1 meter)	Luminous flux	Power	Size W x D x H mm	Suitability	Code
1. Treston NaturLite LED Plus 1200	Controlled via mobile app or separate remote control + ON/OFF button in the luminaire body	2700 - 6500 K	~4000 K: 2800 lx (1000 - 2800 lx depending on the colour temperature)	3200 - 6300 lm (depending on the selected colour temperature)	60 W	1180 x 120 x 50	All Treston and various other industrial workbenches	TNL1200P
Remote control for Treston NaturLite LED Plus 1200	Easy to use and save presets via mobile app. White.					90 x 90 x 12	Treston NaturLite LED Plus 1200	TNLPR
2. Treston NaturLite LED 1200	Touch dim button switch for ON/OFF and dimming in the luminaire body	4000 K	3100 lx	7100 lm	56 W	1180 x 120 x 50	All Treston and various other industrial workbenches	TNL1200
3. Treston NaturLite LED 900	Touch dim button switch for ON/OFF and dimming in the luminaire body	4000 K	2300 lx	5200 lm	42 W	900 x 120 x 50	All Treston and various other industrial workbenches	TNL900
4. Treston NaturLite LED Wing 500	Touch dim button switch for ON/OFF and dimming in the luminaire body	4000 K	800 lx	1750 lm	14 W	430 x 120 x 50 mm (+ bracket 95/120 mm)	Treston Concept, WB, LMT and TP (special brackets on request).	TNL500W

Common features: Dimmable, Lifetime > 50 000 hours (L90B10), Color Rendering Index CRI > 80, High quality LED (MacAdams < 3) Aluminium body, 2 years guarantee, Enclosure protection IP20



- ✓ Adjustability helps to find optimal lighting conditions.
- ✓ Timeless design brings functional beauty to industrial environments and it is never out of style.
- ✓ Easy and fast to install – just click, slide and screw.
- ✓ High-quality LED lights with high-quality drivers are care-free for years to come. Low maintenance, just keep them clean!



Treston NaturLite LED Wing 500

- ✓ Versatile task light
- ✓ Working area with or without shadows
- ✓ Also suitable in the middle of the table



WATCH THIS ANIMATION and get the main facts of the Treston NaturLite LED lights in less than 2 minutes: <https://vimeo.com/241502723>

CUTTING EDGE TECHNOLOGY

Tunable colour tone (2700-6500 K)

Dimmable 1/10-100%

Power 14-60 W (max)

Lean design

Illuminance 800-3100 lx
±10% (1 meter)

2 years guarantee

Lifetime > 50 000 hours (L90B10)

Suitable for all Treston and various
other industrial workbenches

Color Rendering Index
CRI > 80

Enclosure protection IP20

High quality LED
(MacAdams < 3)



Chairs





High-performance industrial chairs with a 10 year warranty

The new Treston chair range offers high-performance seating solutions with maximum customer benefit for any industrial and technical working environment. Our high-quality technical products fulfill the highest requirements, offer outstanding value for money and meet the requirements of various workplaces – from production and packaging to standing work, ESD areas and R&D environments.

Industrial workplaces require industrial chairs

Ergonomically sound chair is a vital part of the well-functioning, ergonomic and user-friendly workstation. Good sitting enables effective and appropriate movements, reduces postural fixity and enables good and relaxed working postures. The ergonomic requirements of workplace chairs in industrial and technical environments are inherently different to those of other areas, such as office. The jobs carried out at manufacturing workstations may involve force, precision skills and repetitive movements, and thus the workplace chair must adapt perfectly to these tasks and working environments in order to support the workers – and their well-being- in the best possible way.

Six models with 36 variations

The new chair range consists of six different models: Multi-purpose Treston Ergo, Treston Plus with an all-inclusive ergonomic package, new generation workplace chair Neon with changeable upholsteries, Flex for standing work, Stool for assistance in workshops and Saddle chair for alternative way of sitting. In addition, there are three surfaces/upholsteries to choose from: a highly resistant polyurethane, comfortable fabric and easy-to-care artificial leather, making it is easy to find the most suitable chair for the working environment from our 36 chair variations.

Safe, sound and economic solution

Treston chairs ensure safety in the workplace by fulfilling the requirements of DIN 68877 and by carrying the GS safety mark, and in addition, our ESD chairs are in compliance with EN 61340-5-1. Besides being safe and ergonomic, our chair selection has a full 10 year warranty*. The Treston chair range is a safe, sustainable and economic solution for industrial seating.

* Saddle chairs 2 years



Find more information about ergonomic sitting from our separate brochure!
treston.com/company/catalogues-and-brochures



Treston Ergo

Multipurpose chair for almost any application in the industry

- User-friendly and quick adjustability
- Excellent price-performance ratio
- Large, ergonomically designed seat and backrest and lumbar support



Treston Plus

The all-inclusive ergonomic package

- Best possible adjustment to body size
- Supports the body in every position
- For any work situation



Neon

New generation workplace chair

- All the same adjustments and features as in ErgoPlus
- In addition changeable upholstery and flex strip for protection of the chair and its environment



Flex standing rest

For best support in standing work and combined workplaces

- 360° rotation of the seat, easy height adjustment of foot ring
- Space saving
- Slip resistant seat



Stools

- Optimal assistance in workshop and heavy duty applications
- Adjustment for seat height



Saddle chairs

- Freedom of movement with ergonomic sitting position
- Adjustment for seat height and seat tilt





Treston Ergo chair with fabric upholstery

	Treston Ergo 30	Treston Ergo 30 ESD	Treston Ergo 35	Treston Ergo 35 ESD
Description	With soft dual-wheel safety castors (conductive with ESD versions) with load-sensitive brakes.		High version with foot ring and glides (conductive with ESD versions).	
Upholstery	The high-quality fabric (black or blue) upholstery is breathable and can both absorb and expel moisture			
Code black	C30BL	C30BL-ESD	C35BL	C35BL-ESD
Code blue	C30B	C30B-ESD	C35B	C35B-ESD



Treston Ergo chair with artificial leather upholstery

	Treston Ergo 30 AL	Treston Ergo 30 AL ESD	Treston Ergo 35 AL	Treston Ergo 35 AL ESD
Description	With soft dual-wheel safety castors (conductive with ESD versions) with load-sensitive brakes.		High version with foot ring and glides (conductive with ESD versions).	
Upholstery	Artificial leather upholstery is washable, resistant to disinfectants and easy to care.			
Code	C30AL	C30AL-ESD	C35AL	C35AL-ESD



Treston Ergo chair with polyurethane foam (PU)

	Treston Ergo 20 PU	Treston Ergo 20 PU ESD	Treston Ergo 25 PU	Treston Ergo 25 PU ESD
Description	With soft dual-wheel safety castors (conductive with ESD versions) with load-sensitive brakes.		High version with foot ring and glides (conductive with ESD versions).	
Upholstery	The PU surface is highly resistant, extremely robust, washable and very easy to clean.			
Code	C20PU	C20PU-ESD	C25PU	C25PU-ESD



Treston Plus chair with fabric or artificial leather upholstery

	Treston Plus 40 BL	Treston Plus 40 BL ESD	Treston Plus 40 AL	Treston Plus 40 AL ESD
Description	With soft dual-wheel safety castors (conductive with ESD versions) with load-sensitive brakes			
Upholstery	Black fabric	Black fabric ESD	Artificial leather	Artificial leather ESD
Code	C40BL	C40BL-ESD	C40AL	C40AL-ESD



Neon chair with fabric upholstery

	Neon 50	Neon 50	Neon 50 ESD	Neon 50 ESD
Description	With soft dual-wheel safety castors (conductive with ESD versions) with load-sensitive brakes			
Upholstery	Black fabric, grey flex strip	Black fabric, orange flex strip	Black fabric ESD, grey flex strip	Black fabric ESD, orange flex strip
Code	C50BL-G	C50BL-O	C50BL-G-ESD	C50BL-O-ESD



Flex standing rest with polyurethane foam (PU)

	Flex 18	Flex 18 ESD	Flex 19	Flex 19 ESD
Description	With soft dual-wheel safety castors (conductive with ESD versions) with load-sensitive brakes.		High version with foot ring and glides (conductive with ESD versions).	
Upholstery	The PU surface is highly resistant, extremely robust, washable and very easy to clean.			
Code	C18PU	C18PU-ESD	C19PU	C19PU-ESD



Stool with polyurethane foam (PU) or artificial leather

	Stool PU	Stool AL	Stool AL-ESD
Description	With soft dual-wheel safety castors (conductive with ESD versions) with load-sensitive brakes		
Upholstery	Polyurethane PU	Artificial leather	Artificial leather ESD
Code	C15PU	C15AL	C15AL-ESD



Saddle chair with fabric or (artificial) leather upholstery

	Saddle B	Saddle G ESD	Saddle AL ANTIB	Saddle AL ESD	Saddle L
Description	With soft dual-wheel safety castors (conductive with ESD versions) with load-sensitive brakes				
Upholstery	Blue fabric	Grey fabric ESD	Antibacterial artificial leather	Artificial leather ESD	Leather
Code	SADDLE B	SADDLE G ESD	SADDLE AL ANTIB	SADDLE AL ESD	SADDLE L

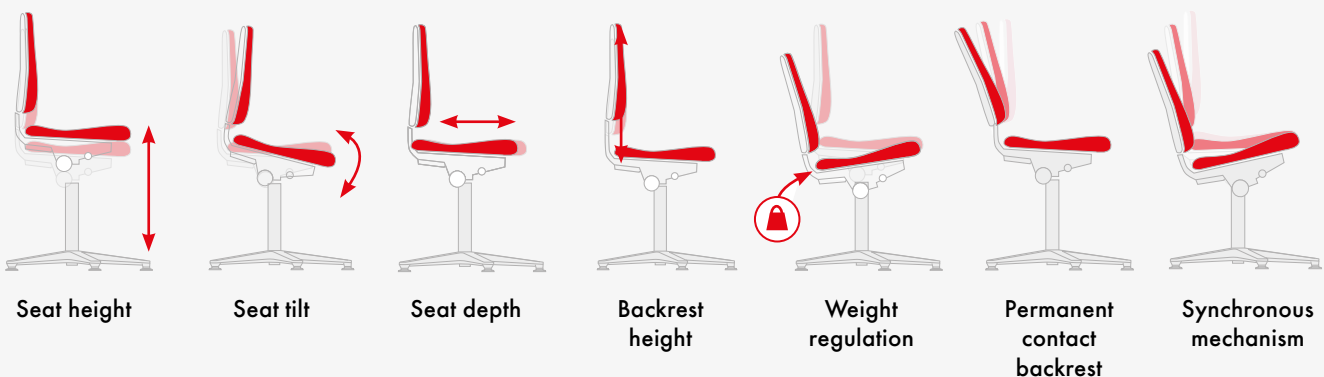

Adjustments and features	Treston Ergo	Treston Plus	Neon	Stool	Saddle chair	Flex – standing rest
Seat height	✓	✓	✓	✓	✓	✓
Seat tilt	✓	✓	✓		✓	
Seat depth		✓	✓			
Backrest height	✓	✓	✓			
Contact backrest	✓					
Synchro mechanism		✓	✓			
Arm rests as an option	✓	✓	✓			
Changeable upholstery			✓			

Code	Description / Upholstery / Colour	Martindale	Seat height, mm*	Seat width, mm	Seat depth, mm	Backrest height, mm	Weight, kg
Stools							
C15PU	Stool 15 polyurethane black		460-630	350	350		7,0
C15AL	Stool 15 artificial leather black	50.000	460-630	400	400		7,0
C15AL-ESD	Stool 15 artificial leather black ESD	50.000	460-630	400	400		8,0
Flex standing rests							
C18PU	Flex 18 polyurethane black		450-650	360	380	200	10,0
C18PU-ESD	Flex 18 polyurethane black ESD		450-650	360	380	200	10,0
C19PU	Flex 19 polyurethane black		510-780	360	380	200	13,0
C19PU-ESD	Flex 19 polyurethane black ESD		510-780	360	380	200	13,0
Treston Ergo chairs							
C20PU	Treston Ergo 20 polyurethane black		440-620	440	410	380	11,5
C20PU-ESD	Treston Ergo 20 polyurethane black ESD		440-620	440	410	380	13,0
C25PU	Treston Ergo 25 polyurethane black		580-850	440	410	380	13,5
C25PU-ESD	Treston Ergo 25 polyurethane black ESD		580-850	440	410	380	15,0
C30AL	Treston Ergo 30 artificial leather black	50.000	440-620	460	470	460	12,0
C30AL-ESD	Treston Ergo 30 artificial leather black ESD	50.000	440-620	460	470	460	13,0
C30BL	Treston Ergo 30 fabric black	50.000	440-620	460	470	460	12,0
C30BL-ESD	Treston Ergo 30 fabric black ESD	40.000	440-620	460	470	460	13,0
C30B	Treston Ergo 30 fabric blue	50.000	440-620	460	470	460	12,0
C30B-ESD	Treston Ergo 30 fabric blue ESD	40.000	440-620	460	470	460	13,0
C35AL	Treston Ergo 35 artificial leather black	50.000	580-850	460	470	460	14,0
C35AL-ESD	Treston Ergo 35 artificial leather black ESD	50.000	530-800	460	470	460	15,0
C35BL	Treston Ergo 35 fabric black	50.000	580-850	460	470	460	14,0
C35BL-ESD	Treston Ergo 35 fabric black ESD	40.000	530-800	460	470	460	15,0
C35B	Treston Ergo 35 fabric blue	50.000	580-850	460	470	460	14,0
C35B-ESD	Treston Ergo 35 fabric blue ESD	40.000	530-800	460	470	460	15,0
Treston Plus chairs							
C40AL	Treston Plus 40 artificial leather black	50.000	450-600	460	410-470	600	18,5
C40AL-ESD	Treston Plus 40 artificial leather black ESD	50.000	450-600	460	410-470	600	19,5
C40BL	Treston Plus 40 fabric black	50.000	450-600	460	410-470	600	18,5
C40BL-ESD	Treston Plus 40 fabric black ESD	40.000	450-600	460	410-470	600	19,5
Neon chairs							
C50BL-G	Neon 50 fabric black grey strips	40.000	450-620	470	420-480	570	18,0
C50BL-G-ESD	Neon 50 fabric black ESD grey strips	40.000	450-620	470	420-480	570	18,0
C50BL-O	Neon 50 fabric black orange strips	40.000	450-620	470	420-480	570	18,0
C50BL-O-ESD	Neon 50 fabric black ESD orange strips	40.000	450-620	470	420-480	570	18,0
Saddle chairs							
SADDLE B	Saddle chair fabric blue	> 50.000	575-820	350	420		7,0
SADDLE G ESD	Saddle chair fabric grey ESD	> 50.000	575-820	350	420		7,0
SADDLE AL ANTIB	Saddle chair artificial leather ANTIB black		575-820	350	420		7,0
SADDLE AL ESD	Saddle chair artificial leather ESD black		575-820	350	420		7,0
SADDLE L	Saddle chair leather black		575-820	350	420		7,0

*According to the DIN 68877, the seat height is measured from the floor to the centre of the seat with a 64-kg load. The maximum load capacity of the chairs is 120 kg.

Accessories for chairs

Product	Description	Code	Code ESD
High glide set	Abrasion-resistant plastic glides have a large surface area and offer superb level of stability. The glides can be retrofitted to all our chairs.	CGLIH	CGLIH-ESD
Soft castor set for hard floor	Dual-wheel safety castors are equipped with load-sensitive brakes, which means that the castors will brake when unloaded. As a standard, we supply soft castors for hard floors, but hard castors for soft floors need to be ordered separately.	CSCAS	CSCAS-ESD
Hard castor set for soft floor		CHCAS	CHCAS-ESD
Soft Stop&Go castor set for hard floors	In case the high chair needs to be moved around the workplace, Stop&Go castors will provide a safe solution. These castors will brake as soon as they are loaded, but when not loaded, the chair is easy to move around.	CSTOP	CSTOP-ESD
4D armrests for Treston Ergo and Treston Plus	Adjustment of height, width and depth with the possibility to swivel.	ARE	
4D ESD armrests for Treston Ergo ESD and Treston Plus ESD	Adjustment of height, width and depth with the possibility to swivel.		ARE-ESD
4D armrests for Neon	Adjustment of height, width and depth with the possibility to swivel.	ARN	ARN-ESD
Chrome-plated foot ring	Foot ring can also be retrofitted to our lower chair models by attaching it to the chair column. Can be used on both ESD and non-ESD models. The height can be easily adjusted without any tools.	CRING	CRING



Trolleys





Freedom of mobility with trolleys

Increased productivity with mobility

Work is not always confined to a single workstation and tools must be moved around accordingly. Lightweight trolleys are ideal for this situation, significantly increasing productivity up to 30%.

The trolleys provide extra work or storage space and can be used, for example, to transport various items, to store measuring units and keep a buffer stock on a production line.

Each task is different and requires dedicated tools. Due to their modularity and versatile accessory components, trolleys are easy to design and adapt to suit a multitude of users and applications.





Universal trolley WTR

Most often combined with WB workstations to provide extra storage space. A good adjustable PC station, measuring station or mobile storage, best suitable for moving equipment around the workstation.



Multi trolley

With three widths and two heights available this trolley is suitable for a wide range of needs. The sturdy shelves can be adjusted and tilted, making it easy to arrange different types of equipment, even heavy loads.



Basic trolley

This trolley can be equipped with shelves, tops and other accessories to fit any application, such as transportation or tool storage.



Adjustable trolley TRTA

For general use wherever a good transportation and storage solution is needed. Two or four shelves available; height of the shelves can be adjusted. Mesh panels can be installed at the ends or on the sides. Also a SMD reel holder version available.



Mobile workstation MLC

An ergonomic and versatile tool with key qualities such as light weight, small size and excellent mobility. Used wherever a laptop is needed on the go.



Storage trolley

Simple solution for mobile storage. The shelves are fitted with rubber mats and the middle shelf is adjustable.



Ergo trolley

Most often combined with Concept workstations to provide extra work and storage space. Can be equipped with a lower shelf, available separately.



SAP trolley

Most often combined with TP workstations to provide extra workspace. Can be equipped with a lower shelf, available separately.



CTR trolley

Most often combined with WB workstations to provide extra workspace. Lower shelf is integrated.

Universal trolley WTR



A good quality, versatile trolley, PC-station, measuring station or mobile storage trolley. Modern industrial design.

The standard trolley has 3 shelves (TS 605), size 650 x 530 mm. Height adjustment of shelves is by allen-key. The vertical profiles are of aluminium. Frames are of epoxy powder coated steel: light grey RAL 7035. The worktops are of 25 mm laminated particle board. Four swivel castors (Ø 125 mm) two of which have brakes, overall height of castor 141 mm.

Universal trolley WTR

Name	Size W x D x H mm	Max load kg	Code	Code ESD
1. Universal trolley	660 x 650 x 1415	150	WTR140	WTR140 ESD
2. Extra shelf	530 x 650	50	TS605	TS605 ESD
3. Adjustable shelf*	530 x 650	50	TAS605	TAS605 ESD
4. Bin profile	Length 525		BP50	BP50 ESD
5. Power channel WJK 40**	Length 470 mm		WJK40	WJK40
6. Keyboard tray NT	525 x 399 x 133 (outer) 500 x 250 x 110 (inner)		-	NT 500 ESD

*Continuous adjustment for depth, height and angle.

** May be fitted with a choice of components, ordered separately. All meet with CE requirements. 3 m cable is included.

**COMPONENTS FOR POWER CHANNEL WJK 40

E1 Double socket (max. 5 pcs/1 cable)	E6 Data connector/shielded for Cat.6 cable
E2 Switch	
E3 Automatic fuse 10 A	
E4 Automatic fuse/earth leakage switch 10 A/30 mA	E8 Pneumatic, quick coupling 3/8"
E5 Emergency-stop-switch	





Multi trolley

Multi trolleys provide an ergonomic mobile workstation. Multi trolleys are available in three different widths: M500, M750 and M900. This means that all our module-sized accessories can be used with the trolleys.

The sturdy shelves can be height-adjusted and tilted. They are also equipped with borders and rubber mats, which keep the load in place.

Multi trolleys support heavy loads, but they are easy to move as well, making it simple to transport heavy equipment, such as measuring units. They are equipped with four swivel castors (Ø 100 mm), two of which have brakes.

Multi trolleys

Name	Module	Outer dims W x D x H mm	Code	Code ESD
Multi trolley 1	M500	530 x 715 x 1130	C 721 41 001P	C 721 49 001P
Multi trolley 1	M750	780 x 715 x 1130	C 721 41 002P	C 721 49 002P
Multi trolley 1	M900	935 x 715 x 1130	C 721 41 003P	C 721 49 003P
Multi trolley 2	M500	530 x 715 x 1630	C 722 41 001P	C 722 49 001P
Multi trolley 2	M750	780 x 715 x 1630	C 722 41 002P	C 722 49 002P
Multi trolley 2	M900	935 x 715 x 1630	C 722 41 003P	C 722 49 003P

Multi trolley 1 includes: one bottom shelf and one adjustable shelf, depth: 505 mm.

Multi trolley 2 includes: one bottom shelf and three adjustable shelves, depth 650 mm.



Multi trolley 2



Multi trolley 1

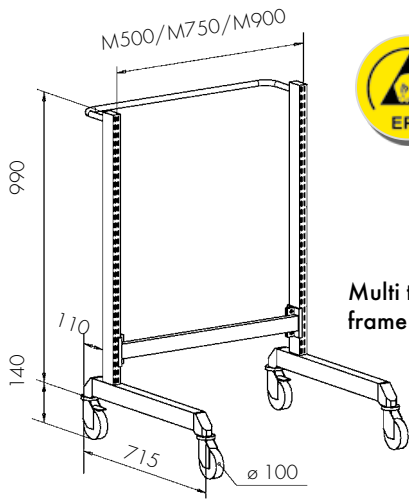

Multi trolley 1 frame

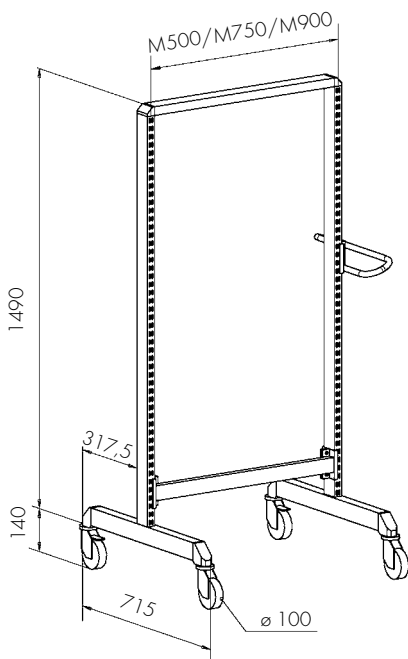

Multi trolley 2 frame

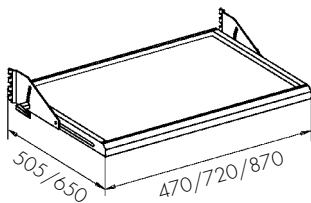

Multi trolley frame

Name	Module	Size W x D x H mm	Max load kg	Code	Code ESD
Multi trolley 1 frame	M500	530 x 715 x 1130	300	860 812-41	860 812-49
Multi trolley 2 frame	M500	530 x 715 x 1630	300	860 818-41	860 818-49
Multi trolley 1 frame	M750	780 x 715 x 1130	300	860 154-41	860 154-49
Multi trolley 2 frame	M750	780 x 715 x 1630	300	860 156-41	860 156-49
Multi trolley 1 frame	M900	935 x 715 x 1130	300	860 155-41	860 155-49
Multi trolley 2 frame	M900	935 x 715 x 1630	300	860 157-41	860 157-49

Multi trolley frame dimensions

Multi trolley	Total height, mm	Depth, mm	Module width	Total width, mm
Frame 1	1130	715	M500/M750/M900	530/780/935
Frame 2	1630	715	M500/M750/M900	530/780/935

Bottom shelf

Name	Module	Size W x D mm	Max load kg	Code	Code ESD
Bottom shelf*	M500	470 x 505	100	860 846-41	860 846-49
Bottom shelf	M500	470 x 650	100	860 847-41	860 847-49
Bottom shelf*	M750	720 x 505	100	860 057-41	860 057-49
Bottom shelf	M750	720 x 650	100	860 067-41	860 067-49
Bottom shelf*	M900	870 x 505	100	860 059-41	860 059-49
Bottom shelf	M900	870 x 650	100	860 069-41	860 069-49

*Compatible only with Multi trolley 1.

Adjustable shelves are equipped with an ESD mat (49) or rubber mat (41).

Adjustable shelf for trolleys

Name	Module	Size W x D mm	Max load kg	Code ESD
Adjustable shelf	M500	470 x 505	100	921 49 001
Adjustable shelf	M500	470 x 650	100	921 49 002
Adjustable shelf	M750	720 x 505	100	921 49 005
Adjustable shelf	M750	720 x 650	100	921 49 006
Adjustable shelf	M900	870 x 505	100	921 49 009
Adjustable shelf	M900	870 x 650	100	921 49 010

Adjustable shelves are equipped with an ESD mat (49) or rubber mat (41).

Adjustable shelf, stepless depth adjustment

Name	Module	Size W x D mm	Max load kg	Code ESD
Adjustable shelf, stepless depth adjustment	M500	470 x 505	50	921 49 003
Adjustable shelf, stepless depth adjustment	M500	470 x 650	50	921 49 004
Adjustable shelf, stepless depth adjustment	M750	720 x 505	50	921 49 007
Adjustable shelf, stepless depth adjustment	M750	720 x 650	50	921 49 008
Adjustable shelf, stepless depth adjustment	M900	870 x 505	50	921 49 011
Adjustable shelf, stepless depth adjustment	M900	870 x 650	50	921 49 012

Adjustable shelves are equipped with an ESD mat (49) or rubber mat (41).

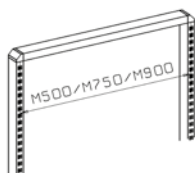

Modular size

The modular (M) size refers to the distance between two upright tubes from the middle of the tube. The modular size is used to find the appropriate accessories.

Basic trolley



Equip your trolleys with shelves, tops and other accessories to fit any application, such as transportation or tool storage. All trolleys are equipped with four swivel castors (Ø 125 mm), two of which have brakes. The basic trolley can be combined with all the M750 accessories.

Basic trolleys

Name	Size W x D x H mm	Max load kg	Code
Basic trolley 1	800 x 715 x 1650	350	C 740 49 101
Basic trolley 3	800 x 715 x 1625	350	C 740 49 003
Basic trolley 5	800 x 715 x 1625	350	C 740 49 105
Basic trolley frame*	800 x 715 x 1625	350	859 859-49

*Basic trolley frame includes bottom shelf and ESD mat.



Basic trolley 1



Basic trolley 3

Basic trolley accessories

Name	Size W x D x H mm	Max load kg	Code
Bottom shelf with ESD mat	720 x 560 x 32	150	852 719-49
Shelf with ESD mat*	720 x 560 x 32	150	852 720-49
Steel shelf*	720 x 560 x 32	150	852 685-49
Steel shelf	720 x 560 x 32	150	852 665-49
Extendable shelf*	720 x 580 x 33	50	852 687-49
Paper roll holder	Roll dimensions max: width 240 mm, Ø 230 mm)		860 310-49
Perforated back panel	718 x 389		861 511-49
Perforated back panel	718 x 612		861 512-49
Perforated back panel, insulated	718 x 612		861 701-49
Perforated back panel	718 x 1003		861 514-49

Trolleys can be combined with all the M750 accessories. For R-hooks, see p. 116.

*including brackets



Basic trolley 5

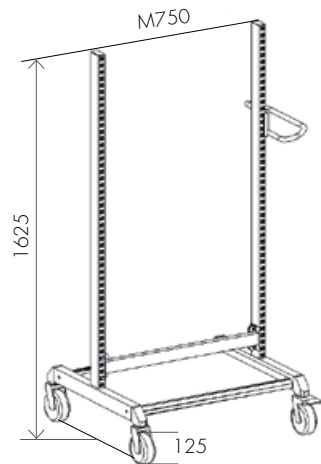

Basic trolley frame



Check the entire Basic trolley selection from our Distinctive Workshops catalogue.



treston.com/company/catalogues-and-brochures



WATCH THIS ANIMATION showcasing the versatile usage options of our technical furniture: Basic trolley | <https://vimeo.com/212715615>

Adjustable trolley TRTA

For general use in workshops, offices, production areas and hospitals. Shelves are powder coated steel, RAL 7035 ESD, height 28 mm. All shelves are individually adjustable. The structure is light but sturdy. The end-frames of the trolley are made of round, powder coated steel tube (25 mm). Four swivel castors (Ø 125 mm), two of which have brakes.



Adjustable trolley TRTA

Name	Size W x D x H mm	Shelf size W x D mm	Max load kg	Code	Code ESD
2-shelf trolley*	890 x 530 x 1020	800 x 430	150	TRTA4082	TRTA4082 ESD
2-shelf trolley*	1090 x 530 x 1020	1000 x 430	150	TRTA4102	TRTA4102 ESD
2-shelf trolley*	890 x 630 x 1020	800 x 530	150	TRTA5082	TRTA5082 ESD
2-shelf trolley*	1090 x 630 x 1020	1000 x 530	150	TRTA5102	TRTA5102 ESD
4-shelf trolley**	1090 x 530 x 1515	1000 x 430	300	TRTA4104	TRTA4104 ESD
4-shelf trolley**	1090 x 630 x 1515	1000 x 530	300	TRTA5104	TRTA5104 ESD

* Shelf adjustments between 200-770 mm

** Shelf adjustments between 200-1340 mm

Extra shelves TRHA

Name	Shelf size W x D mm	Max load kg	Code	Code ESD
Extra shelf	800 x 430	50	TRHA408	TRHA408 ESD
Extra shelf	1000 x 430	50	TRHA410	TRHA410 ESD
Extra shelf	800 x 530	50	TRHA508	TRHA508 ESD
Extra shelf	1000 x 530	50	TRHA510	TRHA510 ESD

End mesh panels NET2

Name	Size W x D mm	Set	Code ESD
End mesh panel	604 x 364	Incl. 2 panels	NET2

The mesh panels can be installed at the ends of the trolley or on the sides. An angle bracket is set on the edge of the upper and lower shelf and the mesh is screwed into place. The 4-shelf trolley can hold 2 mesh panels on top of each other.

Document holder DSA4

Name	Size	Code ESD
Document holder	A4	DSA4 ESD

Semiconductive epoxy powder coated steel. Includes two magnets.

Low M-divider hoops LDH

Name	Size	Code
Divider hoops	460 x 315	LDH

Steplessly adjustable. 4 pcs per set. M-shape (the lowest point 105 mm from shelf). Suitable only 430 mm deep shelves.



Document holder



Low M-divider hoops LDH

Reel holder trolley RRT

The adjustable reel holder trolley is compatible with SMD reels, and suitable for transport and stocking of them. All parts are powder coated steel, RAL 7035 ESD. The trolley has four perforated steel shelves, 1090 x 460 x 28 mm. All shelves are individually adjustable between 200-1605 mm.

The zinc plated reel racks that fit into the shelves are to be ordered separately. The structure is light but sturdy. The end-frames of the trolley are made of round, powder coated steel tube (25 mm). Four turning castors with brakes (Ø 125 mm). The load capacity of one shelf is 50 kg, and the load capacity of the trolley is 200 kg.

Reel holder trolley RRT

Name	Size W x D x H mm	Max load kg	Code ESD
1. Reel holder trolley	1100 x 530 x 1780	200	RRT ESD
2. Reel rack	960 x 426 x 254	50	RR ESD-Z
3. Document holder	A4		DSA4 ESD

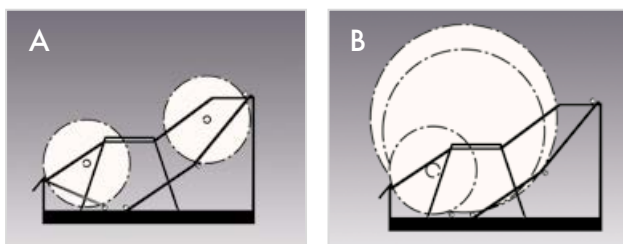
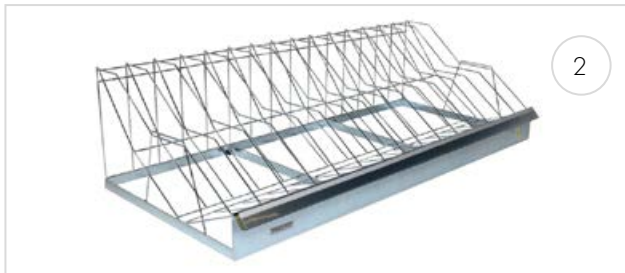

In picture A: Side view of spools and reel racks. The capacity of one rack is 30 fixed compartments for 7" spools of 60 mm width.

In picture B: Side view of spools and reel racks. The capacity of one rack is 15 fixed compartments for 13" and 15" spools of 60 mm width.

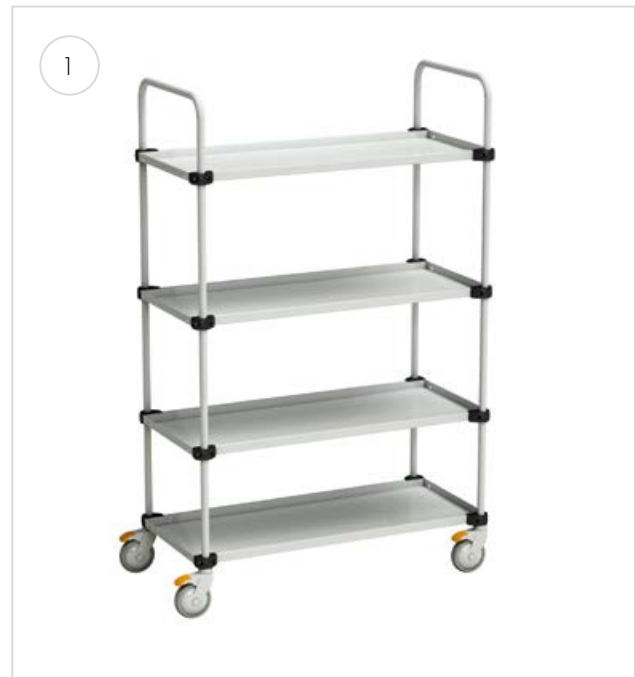

Mobile workstation MLC



The mobile workstations equipped with a laptop enclosure are lockable.

The MLC 405 is a light weight mobile workstation designed to be ergonomic and provide excellent mobility. Accessories can be mounted on the Euro-rail surrounding the work surface. A laptop computer can be placed either on the work surface or under it. The rear recess allows you to conceal the laptop keyboard but leave the screen open and visible. An independent keyboard can be stored either on the work surface or on a keyboard tray (pictured, sold separately). Perforations around the sides and rear of the concealed compartment allow for cables to be connected to the laptop.

- The hinged work surface is made from low-pressure laminate.
- The frame consists of two interlocking aluminium profiles.
- A laptop can be housed on the worktop or stored underneath it to reveal only the screen.
- Cable connections are easily attached through holes around the storage compartment.
- Steel legs with four Ø125 mm castors, two of which are braked.

Mobile workstation MLC

Name	Size W x D x H mm	Top size mm	Max load kg	Code	Code ESD
Mobile workstation	590 x 540 x 800-1200*	520 x 370 x 25	12	MLC405 PG	MLC405 PG ESD

*Height is adjusted by gas spring between 800-1200 mm.

Mobile workstation accessories

Name		Code
1. Keyboard and mouse tray	210 x 620 mm. Equipped with a wrist support.	KH620N
2. Binder mount	Fits a single 75 mm wide binder.	FH1
3. Binder mount	Fits three 75 mm wide binders.	FH3
4. Accessories basket	Blue bin, int. dim. 230 x 155 x 140 mm	AB1930
5. LCD bracket	Load capacity 15 kg, mounting holes 75 x 75 / 100 x 100 apart	MH
6. LCD support arm	For the attachment of MH and MY supports. Max 22" screen.	MS
7. Tablet bracket	For 7-10" tablets. Requires either an MH, MA or MA2 swivel arm.	MY

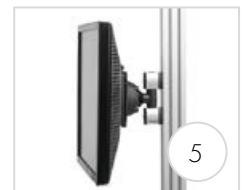
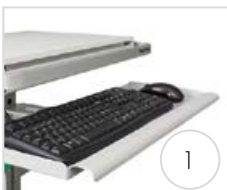

Trolleys for additional workspace

Storage trolley is an easy solution for mobile storage, the storage trolley has an adjustable middle shelf, and the shelves are fitted with standard rubber mats.

Ergo trolley provides extra workspace for the Concept workbench. Lower shelf is available separately. Height adjustment with allen key between 650-900 mm.

SAP trolley provides extra workspace for the TP workbench. Lower shelf is available separately. Height adjustment with allen key between 650-900 mm.

CTR trolley provides extra workspace for the WB workbench. Lower shelf is integrated. Height adjustment with allen key between 690-990 mm.



Trolleys for additional workspace

Name	Size W x D x H mm	Max load kg	Code	Code ESD
1. Storage trolley	650 x 450 x 775	3 x 30	852 773-41	852 773-49
2. Ergo trolley	750 x 500 x 650-900	150	860 422-41P	860 422-49P
Lower shelf for Ergo trolley	595 x 480		860 425-49	860 425-49
3. SAP trolley	700 x 500	150	SAP507	SAP507 ESD
SAP trolley	1000 x 700	150	SAP710	SAP710 ESD
SAP trolley	1500 x 700	150	SAP715	SAP715 ESD
Lower shelf for SAP trolley	700 x 500	40	AT507	AT507 ESD
Lower shelf for SAP trolley	1000 x 700	40	AT710	AT710 ESD
Handle for SAP trolley depth 500			PUSH50	PUSH50
Handle for SAP trolley depth 700			PUSH70	PUSH70
4. CTR trolley	700 x 500	75 / shelf	CTR705	CTR705 ESD

All the light-duty trolleys are equipped with four swivel castors (ø 100 mm), two of which have brakes. ESD versions are also available.



Storage trolley



Ergo trolley



SAP trolley



CTR trolley



Check our carton trolley selection on page 134.



Drawer units





Versatile drawer units

Since work is not always performed in the same place, we provide a comprehensive range of different drawer units for a variety of purposes. You can fix any drawer unit from the same series under a worktop or on a plinth, or equip them with castors to take along to your next workstation.

Efficient storage and control

Our drawer units are great for storing tools and supplies. It is surprising how much time is spent finding tools and other items if they are not stored systematically. The versatile interior combinations of our drawer units guarantee that your supplies are always at hand and in good order.

A comprehensive range of drawer units

We promise that you will find a drawer unit that meets your requirements in our comprehensive range. You can choose from several different heights and drawer and interior combinations. We have selected some combinations for this brochure. For more options, please contact: sales@treston.com.

Drawer units for light loads

These drawer units are designed for storing lightweight items, for example in a testing laboratory or in an office environment.





Light steel cabinet LMC

These steel cabinets are an ideal way of providing individual secure storage for your staff. Drawers are mounted on telescopic ball race slides. Four cabinet sizes, including one drawer/cupboard combination.

Drawer units 30 and 35

These drawer units are fastened under a workbench to provide storage space. Choose from single drawer, two drawers or drawer cabinet. If additional drawers are needed, they can be easily attached to each other. The drawers can be locked to protect the contents.



Drawer unit 45

Choose from two frame heights: 56 or 66 cm, with a plinth for a stand alone solution or with castors for a trolley version. The drawer unit 45 can also be attached under the worktop. All the drawer units have central locking.

Three-level locking system

The majority of our drawer units and cabinets can be equipped with a three-level locking system. This allows both serialisations of individual and identical locks. Contact your Treston representative for additional information. The locking services are always specified for the order.

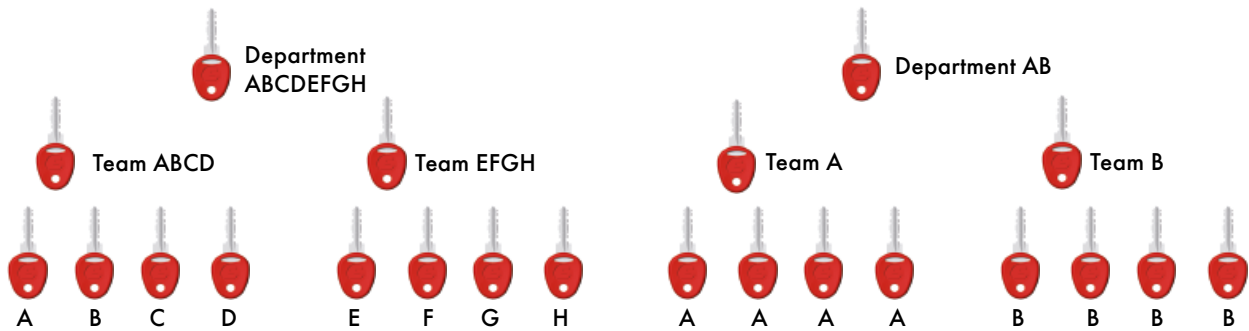

Serialisation of individual locks

Each drawer or cabinet has an individual lock in a production unit, but a master key opens all the locks of the unit. The master keys can also be serialised and the third-level key opens all the drawers and cabinets of all the production units.

Serialisation of identical locks

Each team member needs only one key to access all the drawers and cabinets in a production unit. A master key opens all the drawers and cabinets of all the production units and can also be serialised.

Light steel cabinet LMC

These steel cabinets are an ideal way of providing individual secure storage for your staff. Drawers are mounted on telescopic ball race slides. Four cabinet sizes, including one drawer/cupboard combination. The cabinet

frames are epoxy powder coated steel; drawer fronts are composite board with aluminium handles. Colour light grey, RAL 7035. Mount on benches with brackets (included).

Suitable for WB/TP workbenches and SAP/WTR trolleys



Light steel cabinet, load capacity 15 kg/drawer, 70 % opening

Code	LMC01	LMC02	LMC04	LMC04D
Code ESD	LMC01 ESD	LMC02 ESD	LMC04 ESD	LMC04D ESD
Outer dims W x D x H mm	370 x 460 x 135	370 x 460 x 245	370 x 460 x 455	370 x 460 x 455
Includes drawers (outer height mm)	1 x 100	2 x 100	4 x 100	1 x 100 + cupboard, height 300 mm, open to right

Internal drawer dimensions: 278 x 438 x 75 mm

Cover LMCK2

Description	Code
Needed for mounting cabinets to WB benches and WTR trolley.	LMCK2

Drawer units 30 and 35

These drawer units are fastened under a workbench to provide storage space. Choose from single drawer, two drawers or drawer cabinet. If additional drawers are

needed, they can be easily attached to each other. The drawers can be locked to protect the contents.

Drawer cabinet 35/47 is suitable for storing upright folders.



Drawer units 30 and 35, load capacity 10 kg/drawer, 80 % opening

	30/15	30/22	35/47
Code	859 330-49	859 340-49	860 972-49
Outer dims W x D x H mm	300 x 454 x 150	300 x 454 x 220	350 x 470 x 470
Includes drawers (outer height mm)	1 x 150	2 x 110	1 x 110 + cupboard, height
Internal drawer dimensions:	255 x 400 x 120 mm	255 x 400 x 75 mm	300 x 400 x 70 mm

Fastening sets for drawer unit 30 and 35 (should be selected according to the type of the workbench)

Depth	600 mm	700 mm	750 mm	800 mm	900 mm
Concept, allen key adjustable	890 653-49	-	890 653-49	-	890 653-49
Concept, hand crank adjustable	-	-	890 653-49	-	890 653-49
Concept, motor adjustable	854 463-49	-	854 463-49	-	854 463-49
TowerLine, LMT	-	-	854 463-49	-	-
TP / TPH	-	855 054-49	-	-	855 054-49
WB	-	-	-	855 054-49	-

Not adapted to Concept handcrank bench (depth 600 mm).

Drawer unit 30/22 is now available with a secure and up-to-date electronic code lock.

This electronic locking system replaces keys with a numerical code. The code is easy to change when needed, for example, for a different user and thus this drawer unit is an excellent choice when high convenience and confidentiality are needed.

The locking system is operated with 2 x AAA batteries and is thus independent from an external power supply. Due to an automatic low power (sleep) mode, the batteries last long, and even when the battery power is low, the lock can still be opened 300 more times.

Drawer unit 30/22 with electronic code lock, order code 720010-49.



Drawer unit 45

Centrally locked high quality steel drawer units for storage of tools and small components. Mounted under workbenches with brackets. Also available with castors as a trolley version. Drawer units are epoxy powder coated in grey, RAL 7035. Central locking. Full width drawer handle in anodised aluminium. Smooth and quiet

telescopic ball-race runners with 100 % opening of the drawers. Load-bearing capacity is 60 kg per drawer. Our drawer units are suitable for use in EPAs. The mobile trolleys are available in both ESD and non-ESD versions. New drawer divider sets are available for functional and organized storage space (p. 99).



Choose the drawer unit according to your needs; with castors, plinth or no plinth.

Load capacity 150 kg, 4 swivel castors (ø 100 mm), 2 with brakes. The trolley version comes with a rubber mat that stops items from sliding on the surface.

Combination name

45/56-1

Width Height Version



The maximum load capacity of 100% extendable drawers is 60 kg!

Drawer unit 45/56, 100% opening, load capacity 60 kg/drawer

	45/56-1	45/56-2	45/56-3	45/56-4	45/56-7	45/56-10	45/56-11
Standard	606 49 101	606 49 102	606 49 103	606 49 104	606 49 107	606 49 110	606 49 111
With plinth	606 49 201	606 49 202	606 49 203	606 49 204	606 49 207	606 49 210	606 49 211
With castors	606 49 301	606 49 302	606 49 303	606 49 304	606 49 307	-	-
Height (mm) of the drawer	5 x 100 	2 x 100 2 x 150 	3 x 100 1 x 200 	1 x 100 2 x 200 	2 x 150 1 x 200 	2 x 100 1 x 300 	1 x 200 1 x 300





Internal drawer dimensions: 380 x 500 x 90/140/190/290 mm.

Drawer unit 45/66, 100% opening, load capacity 60 kg/drawer

	45/66-1	45/66-2	45/66-3	45/66-4	45/66-5	45/66-6	45/66-7
Standard	607 49 101	607 49 102	607 49 103	607 49 104	607 49 105	607 49 106	607 49 107
With plinth	607 49 201	607 49 202	607 49 203	607 49 204	607 49 205	607 49 206	607 49 207
With castors	607 49 301	607 49 302	607 49 303	607 49 304	607 49 305	607 49 306	607 49 307
Height (mm) of the drawer	6 x 100 	3 x 100 2 x 150 	1 x 100 2 x 150 1 x 200 	4 x 150 	4 x 100 1 x 200 	2 x 100 2 x 200 	3 x 200

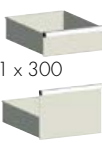
Internal drawer dimensions: 380 x 500 x 90/140/190 mm.

Drawer unit 45/66, 100% opening, load capacity 60 kg/drawer

	45/66-12	45/66-13	45/66-14	45/66-15
Standard	607 49 112	607 49 113	607 49 114	607 49 115
With plinth	607 49 212	607 49 213	607 49 214	607 49 215
Height (mm) of the drawer	3 x 100 	2 x 150 	1 x 100  1 x 200  1 x 300 	2 x 300 

Internal drawer dimensions: 380 x 500 x 90/140/190/290 mm.

Internal drawer dimensions mm	
Width 380	Depth 500
Outer height mm	Inner height mm
100	90
150	140
200	190
300	290



Drawer units with castors are also available as non ESD-versions (code 41 instead of 49).



Cabinet 45/56, door right

	w/o lock	with lock
Standard	606 49 105	606 49 108
With plinth	606 49 205	606 49 208
With castors	606 49 305	606 49 308

Cabinet 45/56, door left

	w/o lock	with lock
Standard	606 49 106	606 49 109
With plinth	606 49 206	606 49 209
With castors	606 49 306	606 49 309

Cabinets include one bottom shelf and one adjustable shelf, shelf load capacity 50 kg.



Drawer cabinet 45/66, door right

drawer 1 x 100	w/o lock	with lock
Standard	607 49 108	607 49 110
With plinth	607 49 208	607 49 210
With castors	607 49 308	607 49 310

Drawer cabinet 45/66, door left

drawer 1 x 100	w/o lock	with lock
Standard	607 49 109	607 49 111
With plinth	607 49 209	607 49 211
With castors	607 49 309	607 49 311

Cabinets include one bottom shelf and one adjustable shelf, shelf load capacity 50 kg.

Drawer units 45/14 and 45/26

Model	Opening	Load capacity kg / drawer	Outer dims W x D x H mm	Height (mm) of the drawer	Code
45/14-1	100%	60	450 x 520 x 140	1 x 100	603 49 001
45/26-1	100%	60	450 x 520 x 260	2 x 100	604 49 001

Internal drawer dimensions: 380 x 500 x 90 mm.



Fastening sets for drawer unit 45 (should be selected according to the type of the workbench)

Depth	600 mm	700 mm	750 mm	800 mm	900 mm
Concept, allen key adjustable	890 653-49	-	890 653-49	-	890 653-49
Concept, hand crank adjustable	-	-	890 653-49	-	890 653-49
Concept, motor adjustable	854 463-49	-	854 463-49	-	854 463-49
TowerLine, LMT	-	-	854 463-49	-	-
TP / TPH	-	855 055-49*	-	-	855 055-49*
WB	-	-	-	855 055-49*	-

Not adapted to Concept handcrank bench (depth 600 mm).

* Standard drawer unit models include fastening set. For drawer unit models with plinth the fastening set 855 055-49 is available only upon order.

For heavy loads we recommend adding a plinth or castors to the drawer unit.

Cover

Description	Code
Needed for mounting drawer unit 45 to WB benches.	855 060-49



Pencil box

Description	Code
Add a pencil box in the drawer to organise small items more efficiently. Cannot be used together with the drawer divider sets.	854 850-49



Hanging file support for 45/300 drawer

Size (inner) W x D x H mm	Code
327 x 492 x 150	W872245-49



The maximum load capacity of 100% extendable drawers is 60 kg!



Drawer interiors

Divider set 1

Model	Code
Drawer 45/100	872991-49
Drawer 45/ 150 and 45/200	872996-49
4 x horizontal dividers 375	

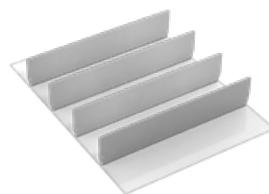

Divider set 2

Model	Code
Drawer 45/100	872992-49
Drawer 45/ 150 and 45/200	872997-49
1 x vertical divider, 8 x divider plate 185	



Divider set 3

Model	Code
Drawer 45/100	872993-49
Drawer 45/ 150 and 45/200	872998-49
1 x vertical divider, 4 x divider plate 125, 4 x divider plate 250	



Divider set 4

Model	Code
Drawer 45/100	872994-49
Drawer 45/ 150 and 45/200	872999-49
2 x vertical divider, 12 x divider plate 125	



Drawer units with castors are also available as non ESD-versions (code 41 instead of 49).





Shelves and cabinets





There's a place for each item

Shelving units and cabinets are an essential element in keeping the workplace tidy and in good order. Shelving units can also be used as room divider elements and are available with ESD protection.

Extended tool life

The service life and condition of tools can be significantly improved through their appropriate storage. They are stored in their own places, protected from dust and dirt, in a locked cabinet.

A versatile storage solution is created by using suitable accessories

An open shelf is not always the best way to store things. Tools, expensive equipment, and small items need another type of solution. Through using lockable drawers or adding doors and walls, an open shelving system is turned into a versatile storage solution. Drawers can be fitted with a variety of interior combinations, to suit the tools stored in them

The Treston shelving system is modifiable

Our storage system is built around the basic component, and extension parts, doors, screens, and other accessories can be added to create an efficient overall solution. In addition the shelf heights can easily be adjusted as needed. Even the load capacity can be increased by adding additional supports.

Treston industrial cabinets allow for a tidy, efficient working environment

No unnecessary time should be used looking for tools and materials. This interrupts work and causes stress. In a well organised cabinet, everything is where it should be.

A ready-assembled cabinet is easy to move to the most convenient location. There are adjustable glides underneath that make it easy to adjust the cabinet so that it stands straight on uneven surfaces. All M750 and accessories, such as shelves, drawer units, perforated panels, and extendable shelves, can be used in selecting accessories for the cabinet.

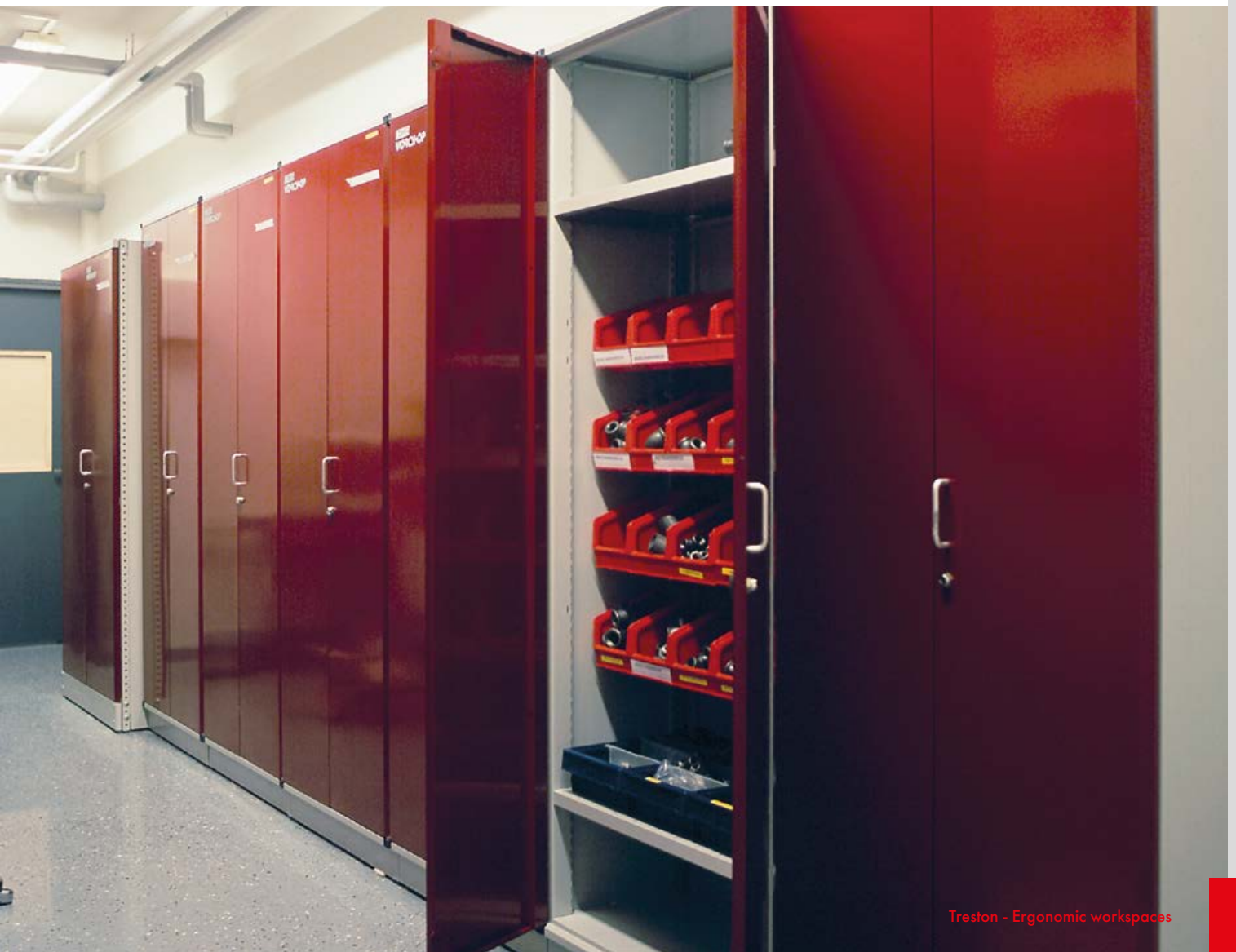

Shelving system

The Treston shelving system can be built as a combination of cabinets and shelves and can be used as a space divider. The shelving system is available in two standard heights, 200 cm and 240 cm and two widths, 80 cm and 100 cm.



1. Standard parts

Name	Size W x D x H mm	Code
Standard part 80/30/200	824 x 300 x 2000	C 313 49 001
Standard part 80/40/200	824 x 400 x 2000	C 314 49 001
Standard part 100/30/200	1024 x 300 x 2000	C 313 49 002
Standard part 100/40/200	1024 x 400 x 2000	C 314 49 003
Standard part 100/50/200	1024 x 500 x 2000	C 315 49 001
Standard part 100/60/200	1024 x 600 x 2000	C 316 49 001
Standard part 80/40/240	824 x 400 x 2400	C 314 49 002
Standard part 100/40/240	1024 x 400 x 2400	C 314 49 004
Standard part 100/50/240	1024 x 500 x 2400	C 315 49 002
Standard part 100/60/240	1024 x 600 x 2400	C 316 49 002

2. Extension parts

Name	Size W x D x H mm	Code
Extension part 80/30/200	804 x 300 x 2000	C 323 49 001
Extension part 80/40/200	804 x 400 x 2000	C 324 49 001
Extension part 100/30/200	1004 x 300 x 2000	C 323 49 002
Extension part 100/40/200	1004 x 400 x 2000	C 324 49 003
Extension part 100/50/200	1004 x 500 x 2000	C 325 49 001
Extension part 100/60/200	1004 x 600 x 2000	C 326 49 001
Extension part 80/40/240	804 x 400 x 2400	C 324 49 002
Extension part 100/40/240	1004 x 400 x 2400	C 324 49 004
Extension part 100/50/240	1004 x 500 x 2400	C 325 49 002
Extension part 100/60/240	1004 x 600 x 2400	C 326 49 002

All standard and extension parts include 6 shelves.

Load capacity 1000 kg/part

width 824 mm 150 kg/shelf



width 1024 mm 150 kg/shelf



The W x D x H rule

All our dimensions follow a WDH rule, where the first dimension is the width (W), the middle the depth (D), and the last the height (H).

Shelving cabinets

1. 100/40/200-1

C 344 07 001 (blue), C 344 49 001 (light grey)

Qty	Name	Size mm	Code blue	Code light grey
1	Cabinet	1030 x 430 x 2010	C 344 07 000	C 344 49 000
	100/40/200			
4	Shelf	1000 x 400	852 231-49	852 231-49

This cabinet is flat packed.

2. 100/40/200-4

C 344 07 004 (blue), C 344 49 004 (light grey)

Qty	Name	Size mm	Code blue	Code light grey
1	Cabinet	1030 x 430 x 2010	C 344 07 000	C 344 49 000
	100/40/200			
2	Shelf	1000 x 400	852 231-49	852 231-49
2	Perforated panel	983 x 500	852 145-07	852 145-49
3	Drawer 400		834 513-49	834 513-49

This cabinet is flat packed.



Move with a pallet truck

The cabinet can be moved with a pallet truck or a forklift when the plinth front panel has been removed. Cabinets are equipped with adjustment screws.



The Treston shelving system includes a wide range of different parts which can be used to create a fully tailor-made solution.

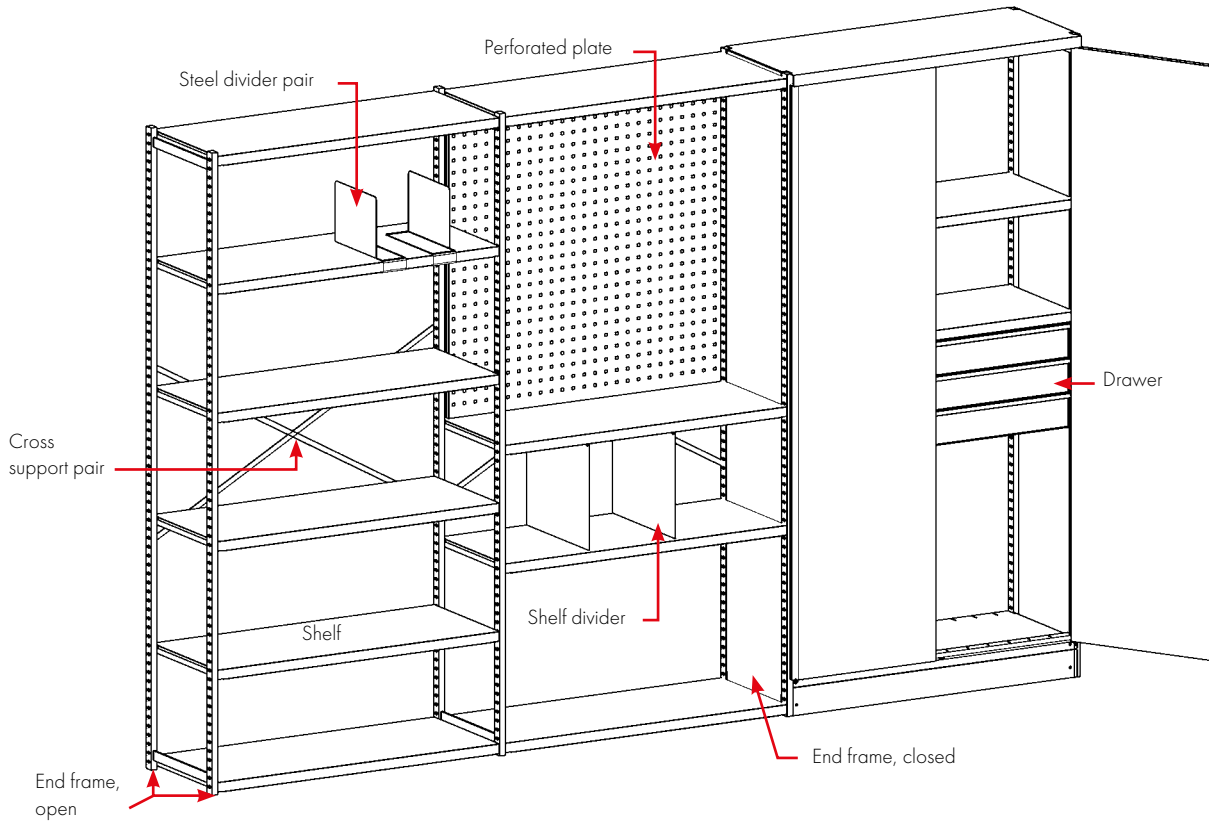

Shelving system components

Name	Size D x H mm	Code
End frame, open	300 x 2000	830 615-49
End frame, open	400 x 2000	830 895-49
Sidewall	400 x 2000	859 440-49
End frame, open	500 x 2000	851 719-49
Sidewall	500 x 2000	859 450-49
End frame, open	600 x 2000	851 725-49
Sidewall	600 x 2000	859 460-49
End frame, open	400 x 2400	851 717-49
End frame, open	500 x 2400	851 721-49
End frame, open	600 x 2400	851 724-49
Cross support pair 1000		852 176-49
Cabinet 100/40/200	1030 x 430 x 2010	C 344 07 000
Cabinet 100/50/200	1030 x 530 x 2010	C 345 07 000
Cabinet 100/60/200	1030 x 630 x 2010	C 346 07 000
Back sheet 1000		859 447-49
Perforated end plate 400	340 x 2000	830 917-07
Screw set (fixing back to back)		838 440-51
Perforated panel 1000	983 x 500	852 145-07
Additional support for shelf 1000		852 267-49

Shelves

Name	Size W x D mm	Max load kg	Code
Shelf	800 x 300	150	852 235-49
Shelf	800 x 400	150	852 234-49
Shelf	1000 x 300	150	852 175-49
Shelf	1000 x 400	150	852 231-49
Shelf	1000 x 500	150	852 185-49
Shelf	1000 x 600	150	852 187-49

Shelf dividers

Name	Size D x H mm	Code
Pair of steel dividers	190 x 285	861 116-49
Shelf divider 400	400 x 180	832 839-49
Shelf divider 400	400 x 260	832 847-49
Shelf divider 400	400 x 370	832 855-49
Shelf divider 500	500 x 260	852 271-49
Shelf divider 500	500 x 370	852 273-49
Shelf divider 600	600 x 260	852 797-49
Shelf divider 600	600 x 370	852 798-49

Drawers and interior combinations

Name	Size W x D x H mm	Max load kg	Code
Drawer 100/100, for 400 deep cabinet	920 x 345 x 107	30	834 513-49
Drawer 100/100, for 500 deep cabinet	920 x 345 x 107	30	834 514-49
1 Middle divider and middle plates			834 507-49
2 Middle divider and middle plates			834 508-49
3 Middle divider and middle plates			834 509-49
4 Pick up bins			834 512-00

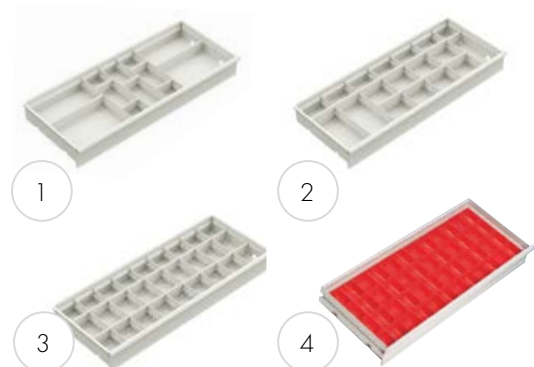

Industrial cabinets

High-quality industrial cabinets are made of epoxy powder coated steel. The frames are painted with light grey RAL 7035 and doors either with blue RAL 5007 or with light grey RAL 7035. The cabinet frames have a lock with two keys, sturdy double leaf-doors and adjustable feet, and with a wide range of accessories it can be easily customized into versatile storage solutions, e.g. for tool storage or shelving. The industrial cabinets are pre-assembled.



NEW: All of the cabinets are now available with an ergonomically designed and functional turn handle mechanism with integrated key lock!

The cabinet can be opened and closed without keeping the key in lock. The key is needed only for locking the door. This locking method can be ordered by adding a T in the end of the product code (e.g. C309 07 000 T).

New handle lock is also available to the industrial storage system and heavy storage system cabinets.

Industrial cabinet combinations



55/100-1 C 301 07 001

Qty	Name	Code
1	Cabinet frame 55/100	C 301 07 000
2	Steel shelf 55	854 349-49



80/100-1 C 305 07 001

Qty	Name	Code
1	Cabinet frame 80/100	C 305 07 000
2	Steel shelf 80	854 345-49



80/100-2 C 305 07 002

Qty	Name	Code
1	Cabinet frame 80/100	C 305 07 000
2	Steel shelf 80	854 345-49
1	Drawer 80	854 346-49

Combination name

55/100-1

Width cm

Height cm

Version

Depth of cabinet: 425 mm



Practical!

100 cm high cabinets have a backstop and rubber mat to be used as an additional work top.





55/160-1 C 303 07 001

Qty	Name	Code
1	Cabinet frame 55/160	C 303 07 000
3	Steel shelf 55	854 349-49



80/160-1 C 307 07 001

Qty	Name	Code
1	Cabinet frame 80/160	C 307 07 000
3	Steel shelf 80	854 345-49



80/160-2 C 307 07 102

Qty	Name	Code
1	Cabinet frame 80/160	C 307 07 000
2	Steel shelf 80	854 345-49
4	Bin rail, M750	859 151-49
21	Stacking bin	1015-5
5	Stacking bin	1525-5



80/200 C 309 49 001

Qty	Name	Code
1	Cabinet frame 80/200	C 309 49 000
4	Steel shelf 80	854 345-49



80/100 C 305 49 001

Qty	Name	Code
1	Cabinet frame 80/100	C 305 49 000
2	Steel shelf 80	854 345-49

Also ESD versions available!

All the industrial cabinets can be ordered as ESD versions by replacing the colour code 07 (blue) with 49 (ESD light grey). This means that in addition to the cabinet frame, the doors will also be painted with light grey ESD paint, RAL 7035. Please remember to use only ESD bins and mats with these ESD industrial cabinets.





Move with a pallet truck

The cabinet can be moved with a pallet truck or a forklift when the plinth front panel has been removed. Cabinets are equipped with adjustment screws.



80/200-1 C 309 07 001

Qty	Name	Code
1	Cabinet frame 80/200	C 309 07 000
4	Steel shelf 80	854 345-49

80/200-2 C 309 07 102

Qty	Name	Code
1	Cabinet frame 80/200	C 309 07 000
2	Drawer 80	854 346-49
2	Steel shelf 80	854 345-49
5	Stacking bin	1525-5
1	Bin rail, M750	859 151-49
1	Extendable shelf 80	854 347-49
1	Perforated panel 736 x 640	835 633-07
2	Perforated panel 288 x 712	854 353-07
1	Pair of support feet	864 730-49



An extendable shelf for the cabinet

When the cabinet is used for storing folders, a separate extending shelf is a good idea. This shelf makes it easy to browse through the folders.



80/200-3 C 309 07 103

Qty	Name	Code
1	Cabinet frame 80/200	C 309 07 000
2	Drawer 80	854 346-49
2	Steel shelf 80	854 345-49
3	Shelf divider H 370/400	832 855-49
1	Perforated panel 736 x 640	835 633-07
1	Extendable shelf 80	854 347-49
1	Pair of support feet	864 730-49
1	Pair of steel dividers	861 116-49
1	Drawer for suspension folders	854 348-49

80/200-4 C 309 07 004

Includes 2 pcs steel shelves 80 , 854 345-49.

Shelving cabinets

Industrial cabinets can be easily used as shelving cabinets by using the 400 mm deep shelf or stacking bins.



Please see our wide bin selection in Storage Systems brochure.



Industrial cabinet accessories

All the M750 accessories fit the cabinet 80 and can be easily installed inside.

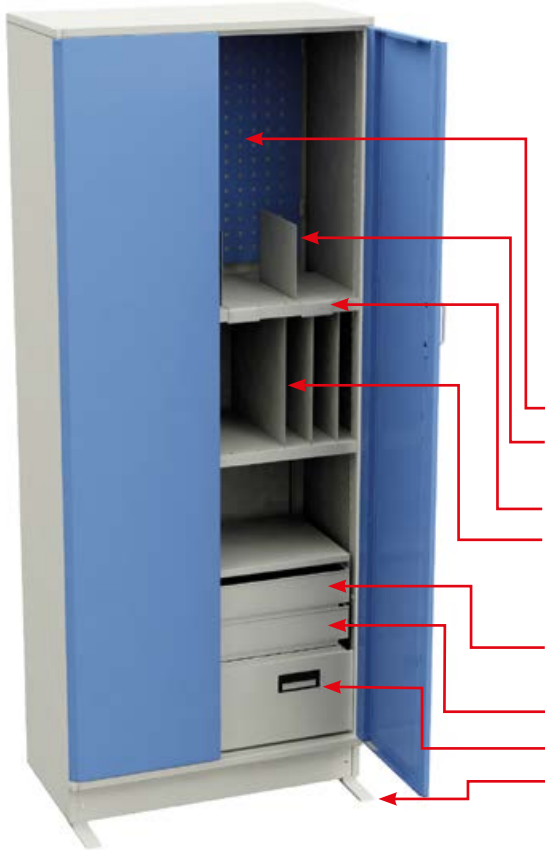

Cabinet frames

Name	Size W x D x H mm	Code
Cabinet frame 55/100	550 x 425 x 1000	C 301 07 000
Cabinet frame 80/100	800 x 425 x 1000	C 305 07 000
Cabinet frame 55/160	550 x 425 x 1600	C 303 07 000
Cabinet frame 80/160	800 x 425 x 1600	C 307 07 000
Cabinet frame 80/160, half doors	800 x 425 x 1600	C 307 07 004
Cabinet frame 80/200	800 x 425 x 2000	C 309 07 000

Cabinet accessories

Name	Size W x D x H mm	Max load kg	Code
Perforated panel for the door or side wall	280 x 740		854 353-07
Perforated panel for the back wall M500	487 x 295		860 951-49
Perforated panel for the back wall M750	736 x 640		835 633-49
Perforated panel for the back wall M750	718 x 1003		835 641-49
Pair of steel dividers	1 x 285 x 190		861 116-49
Steel shelf 55	545 x 391 x 32	100	854 349-49
Steel shelf 80	730 x 396 x 32	100	854 345-49
Shelf divider	1 x 400 x 180		832 839-49
Shelf divider	1 x 400 x 260		832 847-49
Shelf divider	1 x 400 x 370		832 855-49
Extendable shelf 80	730 x 362 x 42	30	854 347-49
Drawer 55	480 x 362 x 90	30	854 344-49
Drawer 80	730 x 362 x 90	30	854 346-49
Drawer for suspension folders	724 x 350 x 240	30	854 348-49
Pair of support feet	40 x 220 x 6		864 730-49
Bin rails M750	742 x 100	50	859 151-49
Rubber mat for cabinet 55/100	550 x 420		836 716-00
Rubber mat for cabinet 80/100	799 x 420		836 715-00

Storage and charging cabinet

A storage and charging cabinet is ideal for storing personal valuables during the workday and at the same time it provides a possibility to charge mobile phones/tablets/laptops. The storage and charging cabinet consists of six lockers and each locker is equipped with a double socket and a secure electronic code lock. This electronic locking system replaces keys with a numerical code.

The locking system is operated with 2 x AAA batteries and is thus independent of an external power supply. Due to an automatic low power (sleep) mode, the batteries are long lasting, and even when the battery power is low, the lock can still be opened up to 300 times.

Storage and charging cabinets are made of epoxy powder-coated steel. The frames are painted with light grey RAL 7035 and doors either with light grey RAL 7035 or with red RAL 3002. On the back panel of the lockers there is perforation for air ventilation. The inner measurements of the lockers are D x W x H 430 x 310 x 205 mm. Storage and charging cabinets are pre-assembled.



Name	Size W x D x H mm	Internal locker dimensions mm	Code
Storage and charging cabinet, grey doors	350 x 540 x 1525	310 x 430 x 205	SCC-41
Storage and charging cabinet, red doors	350 x 540 x 1525	310 x 430 x 205	SCC-25



Perforated panels





Perforated panels are a part of a good organisation

Perforated panels are efficient dividers of space and, at the same time, practical storage facilities for tools and equipment. An industrial screen can be used as a sound-insulating space divider by equipping it with back panel elements with fireproof insulation.

Order and tidiness are appreciated

Order and tidiness cannot be achieved and maintained without there being a place for each tool. Perforated

panels and hooks offer a practical and versatile solution for storing tools and equipment. Perforated panel products are available for direct fastening to the wall or for fastening to upright profiles or tubes.

Hooks also for heavy loads

The hooks can withstand loads of up to 10 kg.



Perforated panels

The perforated back panels are fastened either to the upright tubes (with Concept, Towerline, LMT and TP benches) or accessory frame AKK (with WB bench). The size of the perforation is 9 x 9 mm, center to center 38 mm.

1. Perforated panels for upright tubes

Name	Module	Size W x H mm	Code
Perforated back panel	M500	468 x 389	861 501-49
Perforated back panel	M750	718 x 194	861 510-07
Perforated back panel	M750	718 x 389	861 511-49
Perforated back panel	M750	718 x 612	861 512-07/-49
Perforated back panel, insulated	M750	718 x 612	861 701-07/-49
Perforated back panel	M750	718 x 1003	861 514-07/-49
Perforated back panel	M900	871 x 389	861 516-49
Perforated back panel	M1000	968 x 389	861 532-49
Perforated back panel	M1000	968 x 1003	861 535-07
Perforated back panel	M1200	1168 x 389	861 533-49
Perforated back panel	M1350	1318 x 389	861 521-49
Perforated back panel	M1500	1474 x 389	861 526-49
Perforated back panel	M1800	1774 x 389	861 531-49

Fastened to the upright tubes (see page 48).

2. Back panels for upright tubes

Name	Module	Size W x H mm	Code ESD
Back panel	M500	468 x 389	861 541-49
Back panel	M750	718 x 194	861 550-49
Back panel	M750	718 x 389	861 551-49
Back panel	M750	718 x 612	861 552-49
Back panel	M900	871 x 389	861 556-49

Fastened to the upright tubes (see page 48).

3. Perforated panels for TPH benches

Size W x H mm	Suitable for	Code	Code ESD
1115 x 750	TPH712	RL120	RL120
1415 x 750	TPH715/915	RL150	RL150
1715 x 750	TPH718/918	RL180	RL180
Panel hooks	TPH	RK1	RK1

Mount on TPH benches with panel hooks RK1. Can also be attached to a wall with screws (included).



4. Perforated panels for WB benches

Size W x H mm	Suitable for	Code ESD
668 x 500	AKK70, AKK150	ARL70
968 x 500	AKK180	ARL100

Mount on accessory frame AKK (see page 44).



Perforated industrial screens

These industrial screens are modular, and they can be equipped with all M750 accessories. Industrial screens can be used as space dividers. They also provide noise insulation; the combinations available have perforated back panels on both sides and one side is insulated.

Industrial screens

Name	Size W x D x H mm	Code
Standard part, T-feet	780 x 60 x 1850	C 520 07 101
Extension part, T-foot	750 x 560 x 1850	C 520 07 102
Extension part, L-foot	750 x 310 x 1850	C 520 07 103
Extension part, I-foot	750 x 60 x 1850	C 520 07 104

Includes 6 perforated back panels, 3 pcs./side.
 The standard part includes two feet.
 The extension part includes one foot.

Parts

Name	Size W x D x H mm	Code
T-foot	1850	836 516-49
L-foot	1850	836 532-49
I-foot	1850	836 597-49
Spacer bar	750	835 838-49
Corner joint pair		847 615-51
Perforated back panel M750	718 x 17 x 612	861 512-07/-49
Perforated back panel M750, insulated*	718 x 17 x 612	861 701-07/-49
Upper list	718 x 65	851 907-07

The wall module requires two spacer bars.

* The insulation material used is polyether foam.

All M750 accessories are suitable for the industrial screen.

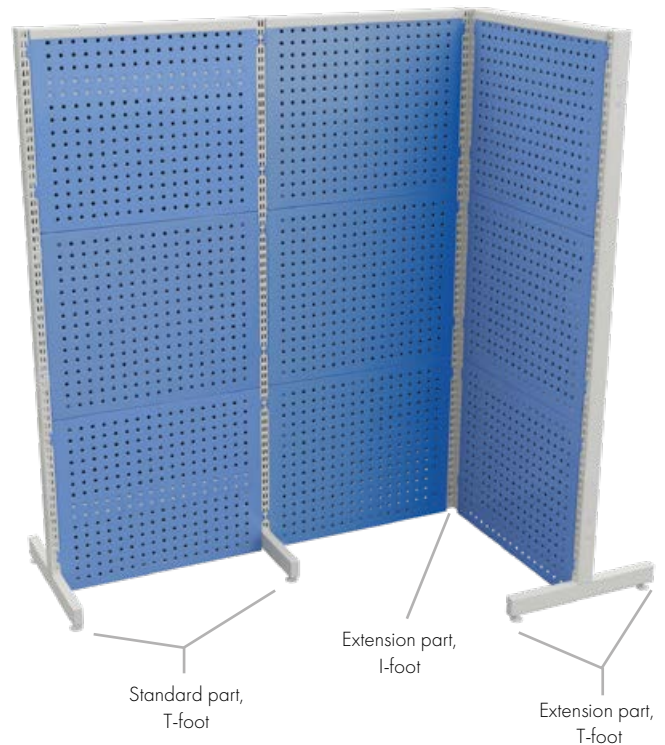

The colour code is included in those product codes that are formed with numbers.

It is either at the end, following the hyphen (e.g. 860 804-49), or in the middle (e.g. C 334-07:000).

Industrial screen accessories

Name	Size W x D mm	Max load kg	Code
Steel shelf M750	740 x 300	50	836 028-49
Steel shelf M750	740 x 400	50	852 770-49
Bin rail M750	742 x 100	50	859 151-49



More accessories starting from page 48

M750 accessories suit these industrial screens.



Steel shelf



Bin rail M750 with brackets and stacking bins.

Tool storage system

Tool storage system requires only 2 m² of floor space and provides 16 m² of storage space. There is no need to fasten it to the floor, as it stands firmly on its own. There is a castor on the lower edge of the panels which makes them easy to move.

The load capacity is 100 kg/panel. Includes 4 panels; additional panels are available (ordered separately). A maximum of 10 panels can be fastened to the tool storage system.

Tool storage system

Name	Size W x H mm	Code
Tool storage system, 4 panels	1025 x 1035 x 2125	830 518-07P
Additional panel	15 x 949 x 1976	830 682-07P



Cabinet style tool storage



WATCH THIS ANIMATION showcasing the versatile usage options of our technical furniture: Tool storage system | <https://vimeo.com/213996808>

Panel hooks

Our selection includes more than 50 different kinds of hooks and brackets for the efficient storage and organ-

isation of tools. All the hooks and brackets can be easily attached to our perforated panels.



R1



R2



R3

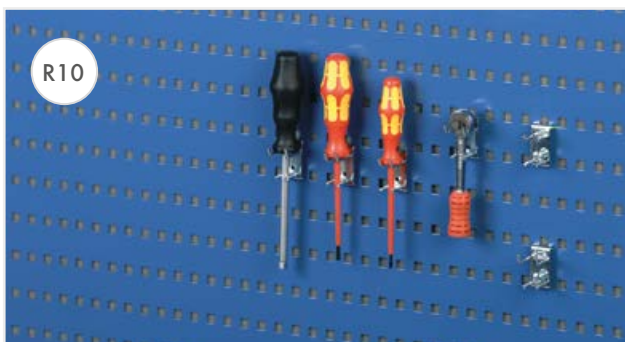

R10



R13

Hook R1

Name	L	Ø	Max load kg	Code
Hook R1	30	3	10	853 207-51
Hook R1	50	4	10	853 208-51
Hook R1	50	6	10	853 241-51
Hook R1	80	6	10	853 209-51
Hook R1	100	4	8	853 210-51
Hook R1	100	6	10	853 211-51
Hook R1	150	4	4	853 212-51
Hook R1	150	6	10	853 213-51
Hook R1	200	4	2	853 214-51
Hook R1	200	6	6	853 215-51
Hook R1	300	6	3	853 216-51
Hook R1	300	8	8	853 217-51

L = hook length mm

All order numbers include 5 pcs.

Hook R2

Name	L	Ø	A	Max load kg	Code
Hook R2	33	3	17	10	853 218-51
Hook R2	43	4	25	10	853 219-51
Hook R2	43	4	40	10	853 220-51
Hook R2	100	6	25	10	853 221-51
Hook R2	150	4	16,5	6	853 222-51
Hook R2	150	6	25	10	853 223-51
Hook R2	200	6	25	10	853 224-51

L = hook length mm

A = free gap mm

All order numbers include 5 pcs.

Hook R3

Name	L	Ø	Max load kg	Code
Hook R3	10	6	10	853 225-51
Hook R3	50	6	10	853 226-51

L = hook length mm

All order numbers include 5 pcs.

Hook R10

Name	L	A	Max load kg	Code
Hook R10	28	9	10	853 227-51
Hook R10	33	17	10	853 228-51

L = hook length mm

A = free gap mm

All order numbers include 5 pcs.

Hook R13

Name	L	Ø	Max load kg	Code
Hook R13	157	3	1	853 229-51

L = hook length mm

The order number includes 5 pcs.

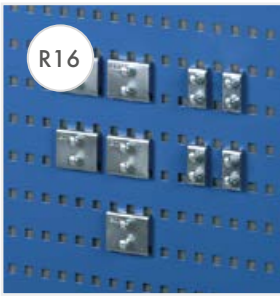

R16

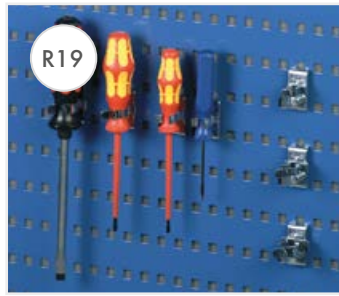

R19

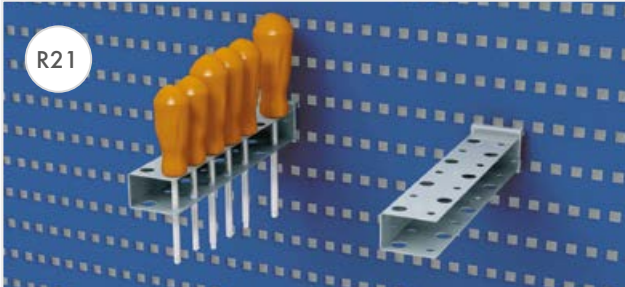

R21



R24



R26



R29



R30



R33

Hook R16

Name	L	Max load kg	Code
Hook R16	20	10	831 514-51
Hook R16	46	10	831 506-51

L = hook length mm

All order numbers include 1 pc.

Hook R19

Name	Ø	Code
Hook R19	13	853 231-51
Hook R19	19	853 232-51
Hook R19	22	853 233-51

All order numbers include 5 pc.

Hook R21

Name	L	Ø	Code
Hook R21	220	12	831 646-51

L = hook length mm

The order number includes 1 pc.

Hook R24

Name	L	Ø	Code
Hook R24	65	17	831 700-51
Hook R24	80	26	831 719-51
Hook R24	100	42	852 167-51

L = hook length mm

All order numbers include 1 pc.

Hook R26

Name	L	Ø	Code
Hook R26	160	10	838 896-51

L = hook length mm

The order number includes 1 pc.

Hook R29

Name	L	Max load kg	Code
Hook R29	40	5	853 234-51
Hook R29	60	5	853 235-51
Hook R29	80	10	853 236-51

L = hook length mm

All order numbers include 5 pcs.

Hook R30

Name	L	Ø	Max load kg	Code
Hook R30	35	4	10	853 237-51
Hook R30	85	6	10	853 238-51

L = hook length mm

All order numbers include 5 pcs.

Hook R33

Name	H	Ø	Code
Hook R33	30	90	832 162-51

H = hook height mm

The order number includes 1 pc.

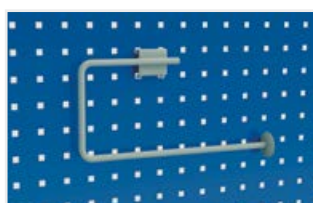
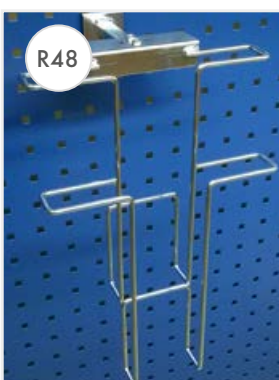
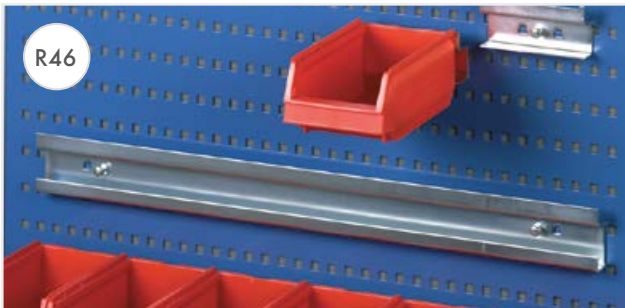
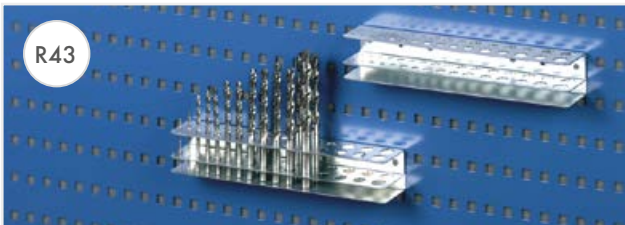
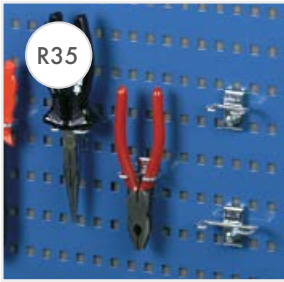

Hook R35

Name	L	A	Max load kg	Code
Hook R35	17	35	5	853 239-51
Hook R35	17	55	5	853 240-51

L = hook length mm

A = free gap mm

All order numbers include 5 pcs.

Hook R37

Name	Ø	Max load kg	Code
Hook R37	40	10	831 433-51
Hook R37	60	10	831 441-51
Hook R37	80	10	831 603-51

All order numbers include 1 pc.

Hook R41

Name	L	Code
Hook R41	556	838 357-51

L = hook length mm

The order number includes 1 pc.

Hook R42

Name	L	Code
Hook R42	238	838 365-51

L = hook length mm

The order number includes 1 pc.

Hook R43

Name	L	Code
Hook R43	238	838 373-51

L = hook length mm

The order number includes 1 pc.

Hook R46

Name	L		Code
Hook R46	112	for stacking bins 1015 and 30-1L	831 794-51
Hook R46	634	bin rail for six stacking bins 1015 and 30-1L	839 086-51

L = hook length mm

All order numbers include 1 pc.

Hook R47

Name	W x D	Max load kg	Code
Hook R47	350 x 120	4	831 654-49

The order number includes 1 pc.

Hook R48

Name	W x D x H	Code
Hook R48	235 x 200 x 370	838 380-51

The order number includes 1 pc.

Paper roll holder

Name	L	Code
Paper roll holder	300	854 043-49

L = max roll width mm



Box holder



Utility box



Folder compartment

Other supplies

Name	Size W x D x H mm	Max load kg	Code
Box holder for four pick up boxes	456 x 165 x 48	5	854 042-49
Pick up box with divider, red	149 x 85 x 48		851 843-00
Pick up box with divider, ESD	149 x 85 x 48		851846-18
Utility box	410 x 155 x 90	4	854 041-49
Folder compartment	466 x 90 x 240	4	854 040-49

Hook sets

Ready-made hook sets help you to get started.

Choose the most suitable hook set for your needs from the following possibilities:

- Hook set 1 Basic light hook set
- Hook set 2 Basic hook set for hand tools
- Hook set 3 Hook set for perforated tool cabinet
- Hook set 4 All inclusive set for hand tools
- Hook set 5 Hook set for heavy tools in perforated tool cabinet



Hook sets

Hooks included in the sets (Code)	Hooks sets							
	L mm	Ø mm	A mm	Set 1	Set 2	Set 3	Set 4	Set 5
R1 (853 207-51)	30	3			5	15	10	10
R1 (853 208-51)	50	4		5	5		10	10
R1 (853 211-51)	100	6						10
R2 (853 218-51)	33	3	17	5	5	5	5	5
R2 (853 219-51)	43	4	25				5	5
R2 (853 220-51)	43	4	40					5
R10 (853 227-51)	28		9					5
R10 (853 228-51)	33		17					5
R19 (853 231-51)		13					5	5
R19 (853 232-51)		19		5	5	5	5	5
R19 (853 233-51)		22			5			5
R21 (831 646-51)	220	12			1			1
R24 (831 719-51)	80	26			1	5	7	3
R24 (852 167-51)	100	42				1	2	3
R29 (853 235-51)	60				5			5
R30 (853 237-51)	35	4		5	5	35	40	10
R33 (832 162-51)	30	90			1	1	2	1
R35 (853 239-51)	17		35		5		5	5
R35 (853 240-51)	17		55					5
R37 (831 441-51)		60			1		3	3
R42 (838 365-51)	35		238		1	1	1	1
R43 (838 373-51)	42		238			1		
Pieces				20	45	69	100	107

L = hook length mm
A = free gap mm



Material flow and packing solutions





MultiLine assembly solutions

Material flow to effective workstations

In the assembly industry, workstations are well planned and designed since they must function as well as possible. MultiLine is expressly designed as an accessory for Treston workspace solutions. Its underlying concept is simple: by connecting workstations to a transfer line you can achieve a more flexible and controllable material flow between workstations without sacrificing characteristics such as usability or ergonomics.

Low investment costs

The MultiLine transfer system has two characteristics, due to which its investment costs remain low. Firstly, it is integrated with an existing system, complementing current processes and thereby avoiding the need for additional investments. Secondly, it is built using standard parts and design, which makes it easy to adapt to any situation and space. It can also be easily and quickly modified when the layout changes.

Optimised for WIP

The core of WIP logic (work in process) comprises allocating a value to stored items between production phases. Money is wasted when half-ready products or components lie unused e.g. in a trolley used as a buffer. If MultiLine is used, only a small quantity of half-finished products lies waiting between production phases.

This problem is amplified if a mistake made in one phase remains unnoticed until a trolley full of defective components is brought to the next phase. With MultiLine both the cost per mistake and the number of mistakes are significantly minimised, because only a few faulty products can be produced before the mistake is noticed.



Please ask for a quote on MultiLine solutions.

Trolley used as a buffer

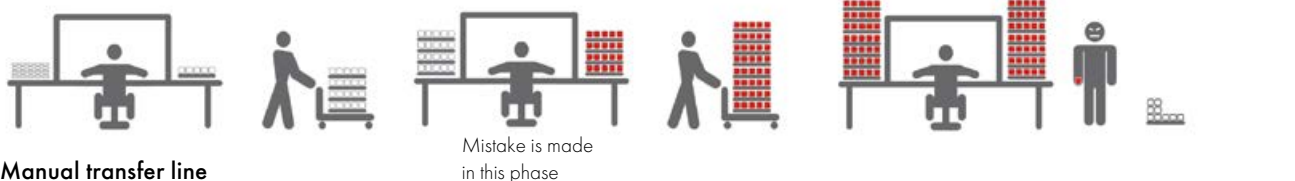

Manual transfer line





FlexFlow flow-through shelving

FlexFlow flow-through shelving can be used as a standalone solution or integrated into a single workstation or assembly line, resulting in faster throughput, less work in process, higher productivity and managed inventories. Your assembly process as a whole will become simpler and more efficient.

FlexFlow is a flexible solution that allows easy addition and removal of components as the role of the workstation changes. FlexFlow can easily be customised to your application and operator using a wide range of accessories. When FlexFlow is equipped for, and adjusted to individual needs the whole production process benefits.

FlexFlow module sizes

FlexFlow is based on module sizes in order to allow it to be easily integrated with other Treston workspace solutions and the MultiLine transfer system. The available sizes are M750 and M900. Both the width and the depth can be increased by combining standard modules that are M750, M900 and M1350 in width, and 900 mm in depth.

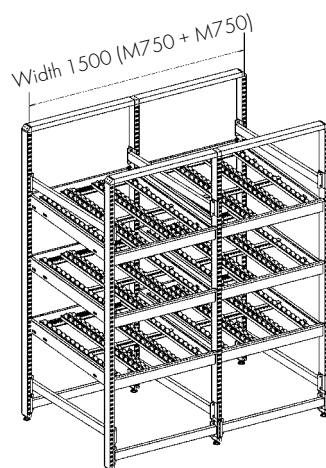

Please ask for a quote on FlexFlow solutions.



Treston Packing Bench TPB

is a well thought-out, safe and easy all-in-one choice

- ✓ Safe, economic and ergonomic all-in-one choice
- ✓ Adapts and grows according to needs
- ✓ 50+ accessories and add-on products available
- ✓ One flat pack contains all the basic equipment
- ✓ Easy to buy, transport and assemble

This packing table adapts and grows according to your needs. You don't need to know what your business will look like in two years' time, as you can add and remove accessories as you go. Start small and add from over 50 accessories based on your needs. TPB comes in one flat pack and is easy to assemble. Perfect packing table option for cost-conscious users.

Carefully selected materials, high-quality finishing, epoxy powdercoated steel parts RAL 7035. Laminate bench top, 25 mm low-pressure laminate.



Packing bench TPB

Size W x D mm	Max load kg	Code
900 x 1500 x 650-900	300	TPB915
900 x 1800 x 650-900	300	TPB918

Packing bench TPB915/TPB918 includes:

Name	Description	Code TPB915	Code TPB918
1. Height adjustable upper steel shelf	Size 310 x 1500/1800 mm. Max load 30 kg. Fixing positions for Treston lighting units under the shelf.	SS150	SS180
2. Adjustable divider hoops	Five adjustable divider hoops (height 400 mm).	PDH	PDH
3. Height adjustable steel perforated panel with bin rail	Size of the panel 1419/1719 x 255 mm. For auxiliary steel shelves and stacking bins. Max load 20 kg.	PP150	PP180
4. Auxiliary steel shelf	Size 217 x 298 x 20 mm, for A4 paper and tape dispensers (max 2 pcs per shelf). Max load 3 kg.	ASSA4	ASSA4
5. Upper paper roll holder	Height adjustable. Axle diameter 25 mm. Max roll width 1400/1700 mm. Max load 40 kg.	PRH ROLL150	PRH ROLL180
6. Lower paper roll holder	Simply hangs on horizontal bars of legs. Depth adjustable. Axle diameter 25 mm. Max roll width 1350/1650 mm. Max load 40 kg.	PRHL ROLL150	PRHL ROLL180

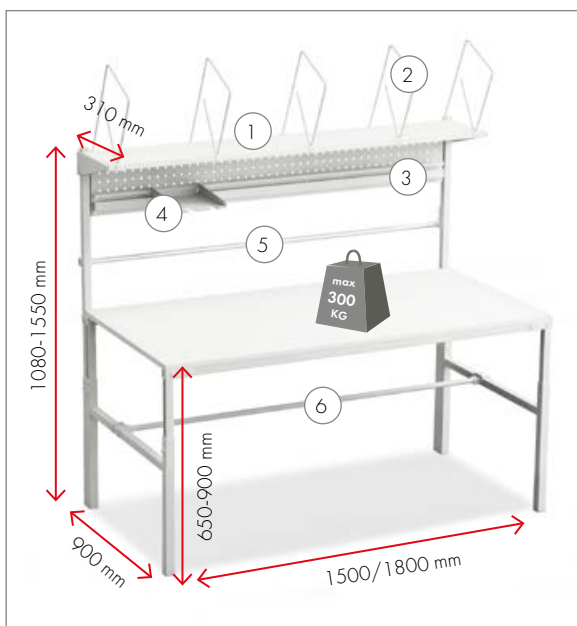

TPB accessories



See additional accessories, lighting units, paper roll holders and cutters on pages 129–131.

Name	Description	Size W x D x H mm	Code
1. Lower steel shelf	Hangs on horizontal bars. Max load 30 kg.	1418 x 460 1718 x 460	LSS150 LSS180
2. Low M-divider hoops	Steplessly adjustable. 4 pcs per set. M-shape (the lowest point 105 mm from shelf).	460 x 315	LDH
3. Recycling material bin	60 ltr bin with steel brackets. Can be positioned on either side. Max load 15 kg.	530 x 280 x 585	PRMB
4. Swivel arm	With lockable, angle adjustable steel tray. Max load 15 kg.	460 x 210	CKV400
5. PC stand	An adjustable holder for either a vertical or horizontal CPU, to mount underneath the bench top.	Vert. 130-140 x 395-500 Horiz. 340-460 x 180-285	CPU
6. LCD swivel arm	The quick-release mechanism is equipped with a standard flat-screen mount 75 x 75 mm and 100 x 100 mm. The arm is double articulated and turns through a radius of 180°. Extends between 95-425 mm from the upright. Max load 10 kg.		MA
Adapter	The adapter is needed for fixing MH/MA/MA2 arms to the TPB C-profiles.		AS2
7. Tool and lighting support	For suspending power tools and lighting units. Includes one C-profile bar with sliding hook.	1500 x 600 1800 x 600	KT150 KT180
8. Side worktop	Easy to fix to the legs of the bench. Can be fixed on the left or right side of the bench and brackets placed either above or underneath. Height adjustable 575-900 mm from floor. Max load 35 kg.	400 x 900	TP904 ST
9. Auxiliary steel shelf*	Shelf for A4 paper and tape dispensers (max 2 pcs per shelf). Mounted on bin profile. Max load 3 kg.	217 x 298 x 20	ASSA4
10. Divider hoops set *	Adjustable divider hoops for shelf of depth 310 mm. 5 pcs per set.	Height 400	PDH
11. Aluminium bin rail	For auxiliary steel shelf (ASSA4), stacking and picking bins. Max. load 15 kg	1419 x 35 x 75 1719 x 35 x 75	BP150 BP180
12. Pull-out steel shelf for printer	Mounting under the bench top. Free space for printer 400 x 500 x 415 mm. Pull-out extent 500 mm. Max load 35 kg.	500 x 510 x 515	PSP50
Extra high upright profiles	If you need more space for uprights. 400 mm taller than standard one.	Height 1470	HKCP147
Cable clip set	5 pcs. The cable clip set will hold cables, etc. securely and neatly in place along the bench frame.		CC12

*Included in the TPB packing bench; also available as an accessory.

Treston Concept bench

accommodates the most demanding needs

- ✓ For all packaging needs, no need for compromises!
- ✓ Wide variety of modules, options and variations
- ✓ Largest number of accessories on the market
- ✓ Sturdy, stable, high-quality

You can choose from various table top material options, sizes and lengths; allen key, hand crank or motor adjustable bench frames; racks for holding bins, cutters, rolls, and more; an endless number of modules and accessories including cutters, tape dispensers, PC stands and more.

Whatever the variation you need, you can build it from Concept and its modular elements. Modules fit together seamlessly, giving you an opportunity to create a complete packaging solution, perfectly matching your needs. Building packaging combinations from varying, yet standard modules makes it possible to create an ergonomically well-functioning packaging solution which is also robust and economic. No need for costly extra modifications or compromises!



Concept bench frames

Frame type	Size W x D x H mm	Max load kg	Code
Allen key adjustable	1500 x 750 x 670-1120	500	100 49 032P
Hand crank adjustable	1500 x 750 x 675-1025	200	101 49 032
Motor adjustable	1500 x 750 x 700-1100	400	103 49 032P
Alley key adjustable	1800 x 750 x 670-1120	500	100 49 033P
Hand crank adjustable	1800 x 750 x 675-1025	200	101 49 033
Motor adjustable	1800 x 750 x 700-1100	400	103 49 033P
Extension part pair *	150		860 634-49
Accessory bar 1500 **	1340 x 40 x 80		860 088-49
Accessory bar 1800 **	1560 x 40 x 80		860 089-49
Castor set	Ø100		834 734-00

*Used with 900 mm deep bench tops to ensure stability when handling objects heavier than 50 kg on the bench.

**Depth adjustable (150 mm) accessory bar to allen key adjustable benches for CPU-holder etc. The bar is included with hand crank and motor adjustable benches.

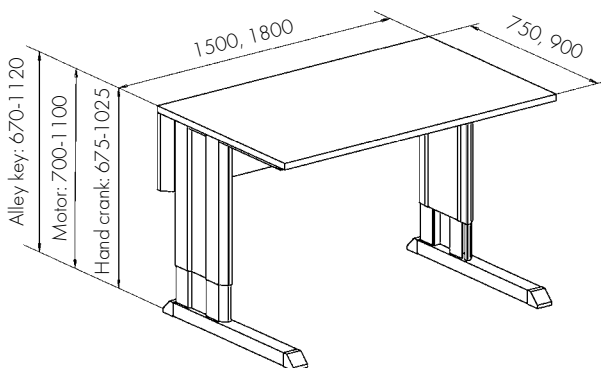

Concept bench tops

Bench top material	Size W x D mm	Code
High pressure laminate	1500 x 750	TT15075-HPL
High pressure laminate	1500 x 900	TT15090-HPL
High pressure laminate	1806 x 750	TT18075-HPL
High pressure laminate	1806 x 900	TT18090-HPL
High pressure laminate	2000 x 750	TT20075-HPL
High pressure laminate	2000 x 900	TT20090-HPL
Low pressure laminate	1500 x 750	TT15075-LPL
Low pressure laminate	1500 x 900	TT15090-LPL
Low pressure laminate	1806 x 750	TT18075-LPL
Low pressure laminate	1806 x 900	TT18090-LPL
Low pressure laminate	2000 x 750	TT20075-LPL
Low pressure laminate	2000 x 900	TT20090-LPL

Concept upright tubes

Name	Length mm	Code
Upright tube	1359	860 024-49
Upright tube	1582	860 025-49
Upright tube module 2 x M750	1359	903 49 001P
Upright tube module 2 x M750	1582	903 49 002P
Upright tube module 2 x M900	1359	904 49 001P
Upright tube module 2 x M900	1582	904 49 002P

Accessories are attached to the Concept bench with the aid of upright tubes or a pre-assembled upright tube module.

Concept accessories



! See additional accessories, lighting units, paper roll holders and cutters on pages 129–131.

Name	Description	Size W x D x H mm	Suitability / module	Code
1. Light and balancer rail	Luminaires are fitted to light/balancer rails which are height and depth adjustable. Max load 15 kg.	1500	2 x M750	918 49 006P
		1800	2 x M900	918 49 008P
2. Roll holder set	Roll holder set for uprights. Axle 25 mm zinc electroplated. Max load 40 kg.	635 (max roll length)	M750	890547-49P
		785 (max roll length)	M900	890548-49P
		1400 (max roll length)	M1500	859 041-49P
		1700 (max roll length)	M1800	859 042-49P
3. Steel shelf	Basic steel shelf for e.g. small cartons and big envelopes. Can also be tilted. Can be equipped with dividers. Max load 50 kg.	740 x 300	M750	836 028-49
		740 x 400	M750	852 770-49
		890 x 300	M900	852 283-49
		890 x 400	M900	852 769-49
4. Adjustable shelf	Deep steel shelf with a mat for general use. Depth adjustment. Can also be tilted. Max load 100 kg.	720 x 505	M750	920 49 005P
		870 x 505	M900	920 49 009P
5. Document shelf	Handy steel document shelf (tilting 10-75°) for plastic bins, papers, small tools, etc. Max load 5 kg.	720 x 265	M750	860 115-49P
		870 x 265	M900	860 399-49P
6. Lower shelf	Steel shelf mount on bench frame. Max load 60 kg. Shelf can be easily equipped with steel tube dividers (page 8, item 3) for storage of cardboard boxes, etc. Depth 600 mm, comes with brackets and accessory bar.	1167 x 600 x 30	Manual 1500	859 225-49P
		1467 x 600 x 30	Manual 1800	859 228-49P
		1167 x 600 x 30	Motor/crank 1500	859 025-49P
		1467 x 600 x 30	Motor/crank 1800	859 028-49P
7. Steel divider pair	Steel plate divider pair for envelopes and small cartons. Fitted on steel shelf. Choose size according to the shelf depth.	285 x 190	Steel shelf	010 004-49
		385 x 190	Steel shelf	010 005-49
8. Document holder	Steel document holder fixed on upright tube. Easily adjustable with the double arm. Max load 5 kg.	A4		928 49 008P
		A3		928 49 009P
9. Equipment tray	With double arm and handle. For small tools and packing accessories such as BLD20 (page 9). Max load 15 kg.	500 x 250 x 125		928 49 002P
10. Adjustable auxiliary top	Ergonomic tilt adjustable tray with double arm (0-25°). Lipped edge of 15 mm. Max load 15 kg.	560 x 340		927 41 001P
11. Keyboard tray for LCD holder	Max load 5 kg.	480 x 260		860 941-49
12. Tooltray	Guarantees a clean packing space, while tools are close at hand. Fitted under worktop. Suitable for all motor benches and for other benches only with 900 mm deep bench tops.	1000 x 60		PTH100
13. LCD holder with double arm	Max load 15 kg.			930 49 002P
14. Holder for Thin Client PC	Holder for Thin Client PC, fixed behind the keyboard tray 860941-49 or 860942-49. Max load 5 kg.	250 x 45-65 x 145	Max. 220 mm Thin Client PC	TCH
15. Pull-out steel shelf for printer	Mounting under the bench top. Free space for printer 400 x 500 x 415 mm. Pull-out extent 500 mm. Max load 35 kg.	500 x 510 x 515		PSP50
16. CC cable clip set CC5 (5 pcs)	Suitable for upright tubes			CC5

Concept accessories



See additional accessories, lighting units, paper roll holders and cutters on pages 129–131.

Name	Description	Size W x D x H mm	Suitability / module	Code
1. Perforated panel	Fastened to the upright tubes. The size of the perforation is 9 x 9 mm, center to center 38 mm. Can be equipped with panel hooks, boxes and trays.	718 x 389	M750	861 511-49
		871 x 389	M900	861 516-49
		1474 x 389	M1500	861 526-49
		1774 x 389	M1800	861 531-49
2. Top shelf	Steel shelf mount on upright tubes. Max load 60 kg. Can be easily equipped with steel tube dividers for storage of cardboard boxes, envelopes, etc.	1467 x 400	M1500	859 015-49
		1773 x 400	M1800	859 018-49
3. Tube divider set (4 pcs)	Carton dividers are fixed on top or lower shelf in 125 mm spacing. One shelf fits two sets.	Ø16 x 336 x 300	Shelf M1500, M1800	859 010-49
4. Roll holder set under worktop	Steel tube (Ø 25 mm) for storage of packing material. Comes with fixing brackets. Max roll length 1200/1500 mm. Max. load 40 kg.	1500		859 044-49P
		1800		859 045-49P
5. Aluminium bin rail	Fixed on upright tubes. For auxiliary steel shelf (page 9), stacking and picking bins. Max load 40 kg.	736 x 55 x 75	M750	BP750C
		889 x 55 x 75	M900	BP900C
		1486 x 55 x 75	M1500	BP1500C
		1792 x 55 x 75	M1800	BP1800C
6. Auxiliary top, fixed brackets	Suitable for printer, boxes, etc. Mount on upright tube. Left and right side version. Max load 40 kg.	400 x 500	Left side	926 41 001P
		400 x 500	Right side	926 41 002P
7. Printer platform slideable	Printer shelf with sliding platform for easy replacement of the label roll. Mount on upright tube. Max load 30 kg.	315 x 530		859 060-49
8. Rotating tool panel	Fixing frame with double arm. Max load 15 kg.	513 x 320		880 865-49P
9. Perforated panel for rotating tool panel		470 x 300		860 951-49
10. Tool trough M500 for rotating tool panel		470 x 150		860 952-49
11. Bin rail M500 for rotating tool panel	Aluminium bin rail for auxiliary steel shelf (page 9), stacking and picking bins.	486 x 55 x 75		BP500C
12. CPU / printer holder, bar clamp (under worktop)	Brackets for CPU, printer, etc. Fixed on accessory bar of bench. Max load 20 kg.	>150 x 500 x 85		860 551-49
13. PC / folder box	Fitted to upright tube. Max load 5 kg.	130 x 290 x 330		860 983-49
14. Roll holder for upright tube	For a small roll, e.g. plastic bag roll. Max roll Ø150 mm, max length 300 mm.	Ø10 x 300		860 841-49
15. Bottle holder	Steel bottle holder for upright tube.	Ø100 mm		859 063-49
16. Laptop/ printer shelf with arm	Tray with double arm for laptop, printer, etc. Edge height 15 mm. Max load 25 kg.	365 x 365		930 49 001P

TPB and Concept accessories



Name	Description	Size W x D x H mm	Suitability	Code
1. Auxiliary steel shelf	Shelf for A4 paper and tape dispensers (max 2 pcs per shelf). Mounted on bin profile. Max load 3 kg.	217 x 298 x 20	TPB, Concept	ASSA4
2. Stacking bin set	Four bins made of blue polypropylene (PP).	2 pcs 230 x 155 x 140 2 pcs 185 x 125 x 115	TPB, Concept	SBS4
3. Tool holder box	With two blue plastic bins type 3020.	400 x 300 x 150	TPB, Concept	PPH TXL
4. Drawer unit	Mount on benches with bracket (included).	370 x 460 x 140	TPB, Concept	LMC01
5. Fixed tape dispenser	Feeds tape from a roll; for a tape roll with a 76-mm socket. Includes screws to fix the dispenser to ASSA4. Max roll Ø 120 mm and width 50 mm.		TPB, Concept	FTD50
6. Basic label dispenser	Feeds labels from a roll, space for several rolls. Fits on ASSA4 or can be placed in a shelf or tray. Can be fixed with screws. Max roll Ø 220 mm and width 210 mm.	214 x 128 x 120	TPB, Concept	BLD20
7. Paper roll dividers	Keeps the packing material rolls in place. Made from MDF. For axle Ø 25 mm. Includes 2 dividers and 2 spring locks.	Ø 170 mm	TPB, Concept	RD25
8. Pull-out recycling material bin	Fixed under worktop with steel rails. Bin 60 ltr. Max load 15 kg.	286 x 570 x 650	TPB, Concept	PRMB3
9. Utility box	Mount on perforated panel. Max load 4 kg.	410 x 155 x 90	TPB, Concept	854041-49
10. Tray R47	Mount on perforated panel. Max load 4 kg.	350 x 120	TPB, Concept	831654-49
11. Paper roll holder	Mount on perforated panel. Max roll width 300 mm.		TPB, Concept	854043-49
12. Outlet panel	5 Schuco wall sockets, switch and 3 m cable.		TPB, Concept	PRK5
13. Pull-out steel shelf for printer	Mounting under the bench top. Free space for printer 400 x 500 x 415 mm. Pull-out extent 500 mm. Max load 35 kg.	500 x 510 x 515	TPB, Concept	PSP50
14. Treston NaturLite LED Plus 1200	Lean aluminium body, tunable white (2700-6500 K), dimmable, max 2800 lx, 60W, opal cover. Controlled via free mobile app or remote control (sold separately).	1180 x 120 x 50	TPB, Concept	TNL1200P
15. Remote control for Treston NaturLite LED Plus 1200	Easy to use and save presets via mobile app. White.	90 x 90 x 12	Treston NaturLite LED Plus 1200	TNLPR
16. Treston NaturLite LED 1200	Lean aluminium body, dimmable bright light, max 3100 lx, 56 W, 4000 K, opal cover.	1180 x 120 x 50	TPB, Concept	TNL1200
17. Treston NaturLite LED 900	Lean aluminium body, dimmable bright light, max 2300 lx, 42 W, 4000 K, opal cover.	900 x 120 x 50	TPB, Concept	TNL900
18. Treston NaturLite LED Wing 500	Sidelight. Lean aluminium body, dimmable, max 800 lx, 14W, 4000 K, opal cover.	430 x 120 x 50	Concept	TNL500W

Packing material roll stands

① High packing material roll stand

High stand for two rolls. The rolls are adjustable in height. Axle diameter 25 mm. Max roll Ø 800 mm. Can be equipped with extra roll holder set, castor set and cutter PPC. Max load 40 kg per roll.

Size W x D x H mm	Module	Max roll width mm	Code
1380 x 715 x 1500	M1350	1200	890 520-49P
1530 x 715 x 1500	M1500	1400	890 521-49P
1830 x 715 x 1500	M1800	1700	890 522-49P



! Bracket pair for cutter, page 131

② Low packing material roll stand

Low stand for one roll. The roll is adjustable in height. Axle diameter 25 mm. Max roll Ø 800 mm. Can be equipped with extra roll holder set, castor set and cutter PPC. Max load 40 kg per roll.

Size W x D x H mm	Module	Max roll width mm	Code
1380 x 715 x 1000	M1350	1200	859 103-49P
1530 x 715 x 1000	M1500	1400	859 105-49P
1830 x 715 x 1000	M1800	1700	859 108-49P



③ Castor set for packing material roll stands

4 swivel castors Ø 100 mm, 2 with brakes. Attached directly to the stands.

Size mm	Code
Ø 100	834 734-00

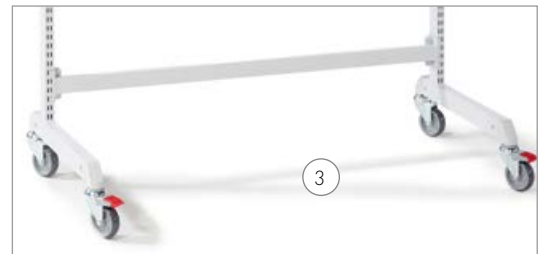

④ Extra roll holder set

Extra roll holder set for packing material roll stands. Including brackets. Axle diameter 25 mm, zinc electroplated. Max load 40 kg.

Module	Max roll width mm	Code
M1350	1200	859 040-49P
M1500	1400	859 041-49P
M1800	1700	859 042-49P



Cutters

① Cutter PPC

The round cutting knife will slice through paper and cardboard with ease. Can be affixed to the bench top or alternatively to the upright profiles with fixing brackets PPC FB.

Size W x D x H mm	Module	Cutting width mm	Code
1350 x 130 x 200	M1350	1110	PPC135
1485 x 130 x 200	M1500	1250	PPC150
1785 x 130 x 200	M1800	1550	PPC180



② Fixing brackets for cutter

In order to obtain an ergonomic position, the cutters can also be affixed to the upright profiles of all the workbenches using these fixing brackets. The fixing brackets make the cutter both height and tilt adjustable, tilt 30 degrees. Cutter is ordered separately.

Suitability	Code
TPB/Concept upright profiles	PPC FB



③ Bracket pair for cutter

Cutter PPC can be fitted to the packing material roll stand with the bracket pair. Height adjustable. Cutter is ordered separately.

Suitability	Code
Packing material roll stands	890 511-49P



Trolleys

1 Low carton trolley LCT610

Trolley for large cartons. Three dividers can be assembled crosswise or lengthwise. The fourth divider is a push handle.

Frame and shelf are of epoxy powder-coated steel in grey RAL 7035. Four swivel castors (Ø 100 mm), two of which have brakes. Shelf height above the ground 160 mm.

Size W x D x H mm	Shelf size W x D mm	Code
1080 x 630 x 1020	1000 x 630	LCT610



2 High carton trolley HCT410

Trolley for packing cartons. Shelves are equipped with steplessly adjustable steel M-divider hoops. Larger hoop height 540 mm, lowest point 330 mm above the shelf, smaller hoop height 315 mm, lowest point 105 mm above the shelf.

Frame and individually height adjustable shelves are of epoxy powder-coated steel in grey RAL 7035. Four swivel castors (Ø 100 mm), two of which have brakes.

Size W x D x H mm	Shelf size W x D mm	Code
1090 x 530 x 1515	1000 x 430	HCT410



3 Carton trolley

Steel trolley for storage of cartons under the bench. Trolley is equipped with four swivel castors (Ø 50 mm), two of which have brakes. Grey epoxy powder coated in RAL7035. Comes with seven steel divider hoops, height 300 mm. Max load 60 kg.

Size W x D x H mm	Shelf size W x D mm	Code
1180 x 600 x 425	1170 x 600	859070-41P



4 Recycling material trolley PRMT

The recycling trolleys are ideal for placing underneath or beside the packing bench. The bins are adjustable in angle for ease of use! The trolley comes with four swivel castors, two with brakes. Available in single and double version.

Size W x D x H mm	Code
350 x 625 x 765	PRMT 1
680 x 625 x 765	PRMT 2



5 Packing material trolley PMT

The packing material trolley is ideal for storing papers, envelopes and utilities such as tape underneath the workstation or bench. The shelves are adjustable in height and the metal dividers are adjustable in width by allen-key.

Size W x D x H mm	Code
680 x 625 x 640	PMT 606
1085 x 625 x 640	PMT 610



Only a selection of our trolleys is presented in this brochure. Please visit our webpage for the full range.

Drawer unit spare parts

Name	Size W x D x H	Compatibility	Code
Cover with an ESD mat, assembled	450 x 518 x14	45 drawer unit	W87 2107-49
Cover with a rubber mat, assembled	450 x 518 x14	45 drawer unit	W87 2107-41
Cover without mat	450 x 518 x14	45 drawer unit	872 107-49
ESD mat, light grey	445 x 513	45 drawer unit cover	836 750-00
Rubber mat, black	445 x 513	45 drawer unit cover	836 740-00
Shelf for cabinet version		45 drawer unit	872 043-49
Bracket pair for the shelf		45 drawer units	872 045-51
Castor set Ø 100 ESD		45 drawer units	852 774-00

Drawer interior spare parts for drawer unit 45

Name	Compatibility	Code
Vertical divider	45/100 drawer	872300-49
Vertical divider	45/150 and 45/200 drawers	872301-49
Divider plate L=125	45/100 drawer	872302-49
Divider plate L=185	45/100 drawer	872303-49
Divider plate L=250	45/100 drawer	872304-49
Divider plate L=375	45/100 drawer	872305-49
Divider plate L=125	45/150 and 45/200 drawers	872306-49
Divider plate L=185	45/150 and 45/200 drawers	872307-49
Divider plate L=250	45/150 and 45/200 drawers	872308-49
Divider plate L=375	45/150 and 45/200 drawers	872309-49
Divider holder set for drawer interiors (incl. 12 pcs)		853003-00

Spare parts for industrial cabinets

Name	Compatibility	Code
Rubber mat 550 x 420	Industrial cabinet 55/100	836 716-00
Rubber mat 799 x 420	Industrial cabinet 80/100	836 715-00

Castors

Name	Compatibility	Screw	Code
Castor set Ø 100 ESD	45 drawer units, Storage trolley, Ergo trolley	M10	852 774-00
Castor set Ø 100	45 drawer units, Storage trolley, Ergo trolley	M10	852 768-00
Castor set Ø 100	Multi trolley, Concept and TP benches	M12	834 734-00
Castor set Ø 125	Basic trolley	M12	834 740-00
Castor set Ø 100 ESD	Multi trolley, Concept and TP benches	M12	860 429-00
Castor set Ø 50	Transport skate	M10	853 176-00
Castor set Ø 50 ESD	Transport skate ESD	M10	853 175-00

Arm adapters for MH/MA/MA2/MA3

Profile type	Workbench model	MH	MA	MA2	MA3
C-profiles	TPH, TPB	AS2	AS2	AS2	AS3
Upright profiles	Concept, TP, LMT, TowerLine	AS2	AS2	AS2	AS3

Arm adapters for Concept/TP/LMT/TowerLine accessories with arms (for example 93049002P)

Profile type	Workbench / trolley model	40 mm arm	60 mm arm
C-profiles	TPH, TPB	-	E824081-49
AL2X aluminum profiles	WB	890524-49	890525-49
Aluminum profiles	WTR	E821573-49	E821572-49



TRESTON
DEDICATED TO HUMAN WORKSPACE

DISTINCTIVE
WORKSHOPS

PRODUCT CATALOGUE 2018



Discover also our
**Workshop
product range**

Our workshop drawer cabinets, tool panels and workbenches are designed to withstand heavy loads and strenuous use in workshops, repair shops and industrial environments.

The long lifetime of our furniture guarantees productivity and a satisfied user. Our workshop furniture is also well known in teaching environments.



TRESTON
DEDICATED TO HUMAN WORKSPACE

Storage
SYSTEMS

PRODUCT CATALOGUE



Discover also our
**Storage Systems
product range**

Our plastic storage drawers are durable and easy to clean, and can be customised into a complete storage system if necessary. Our product range also includes various stand and trolley solutions, for the more efficient use of storage space and easier movement of stored goods.

We also have storage furniture for EPAs. In addition, some of our storage solutions are based on reprocessed plastic.

HEADQUARTERS

Treston Oy
Sorakatu 1
FI-20730 Turku
Tel. +358 10 4469 11
Fax +358 10 4469 789
sales@treston.com
www.treston.com

FACTORIES

Treston Oy, Turku plant
Sorakatu 1
FI-20730 Turku
Tel. +358 10 4469 11
Fax +358 10 4469 789
sales@treston.com
www.treston.fi

Treston Oy, Jyväskylä plant
PO Box 33 (Sohlberginkatu 10)
FI-40351 Jyväskylä
Tel. +358 10 4469 11
Fax +358 10 4469 290
sales@treston.com
www.treston.fi

FRANCE

Treston France SARL
Z.A.C. de la Bonne Rencontre
1, voie Gallo Romaine, Quincy-Voisins
77334 Meaux Cedex
Tel. +33 1 64 17 11 11
Fax +33 1 64 17 11 10
infofr@treston.com
www.treston.fr

GERMANY

Treston Deutschland GmbH
Friedrich-Ebert-Damm 143
22047 Hamburg
Tel. +49 40 8816 5022 - 0
Fax +49 40 8816 5022 - 10
info.de@treston.com
www.treston.de

Treston Deutschland GmbH
Niederlassung Raunheim
Frankfurter Straße 101
65479 Raunheim
Tel. +49 6142 992 50
Fax +49 6142 218 75
mail.de@treston.com
www.treston.de

RUSSIA

Treston Russia LLC
197375, Russia, Saint-Petersburg,
Marshala Novikova street 42
Tel. +7 812 677 76 20
info.ru@treston.com
www.treston.ru

SWEDEN

Treston AB
Tumstocksvägen 9 A
187 66 Täby
Tel. +46 8 511 791 60
Fax +46 8 511 797 60
info.se@treston.com
www.treston.se

UNITED KINGDOM

Treston Ltd
Treston House
5b Bone Lane, Newbury
Berkshire, RG14 5SH
Tel. +44 1635 521521
Fax +44 1635 37452
salesuk@treston.com
www.treston.com

USA

Treston, Inc.
156 Bluffs Court
Canton, GA 30114
Tel. +1 770-721-7980
Fax +1 770-720-6584
infousa@treston.com
www.treston.us

Premium partners

BENELUX

Human Workspace BV
Mechelaarstraat 17
4903 RE Oosterhout
Tel. +31 162 454 383
Fax +31 162 434 712
infofen@humanworkspace.nl
www.humanworkspace.nl

NORWAY

Industrimøbler AS
Solheimveien 50
1473 LØRENSKOGP
tel. +47 22 25 05 00
post@industrimobler.no
www.industrimobler.no

POLAND

Treston Ergona
ul. E. Orzeszkowej 6 lok. 2A
05-825 Grodzisk Mazowiecki
Tel. +48 604 11 98 64
info@ergona.pl
www.ergona.pl

Treston Global Network



Treston has a long history in professional furniture design and manufacture, and well over three decades of experience in ergonomic workspace development. Our design and manufacturing facilities are located in Finland.

Thanks to our global sales network, you can receive local support and customer service anywhere in the world. We have offices in Europe and North America as well as an extensive network of selected dealers in more than 30 countries.